

BERT | FRANK

DISTRIBUE PAR



Christian SCELLES
Ch.scelles@artidesign.eu
Tel : 06 14 62 64 93

TECHNICAL SPECIFICATONS



Bert Frank is an award-winning British luxury lighting brand founded in 2013 by designer Robbie Llewellyn and factory owner Adam Yeats. Since launching our first design our range has expanded to include 31 lighting collections, all of which are designed at our London studio and built at our factory located in the heart of Birmingham's industrial quarter. We work with expert artisan producers across the stone, glass and ceramics industry, combining age old manufacturing techniques with cutting edge technology to explore materiality and drive our design process forward. Every detail of our designs is carefully considered, crafted and made to the highest standard. There are no short cuts, no compromises in quality, just beautifully engineered products made to last a lifetime.

CONTENTS

AEGIS	06	FAROL	26	PENNON	44	SPATE	68
ARBOR	08	FLAGON	28	PUGIL	46	STASIS	70
BERAN	12	GLAIVE	30	REVOLVE	48	TANTO	72
BIDE	14	KERNEL	32	RIDDLE	52	TRAVE	74
BRACE	16	KINS	34	RIFT	56	TRIARC	76
CASK	18	LIZAK	36	ROTE	58	VIMA	78
COLT	20	MASINA	38	SEDGE	62	YEW	82
CORBEL	24	OCCULO	40	SHEAR	64		



“HAVE NOTHING IN YOUR
HOUSES THAT YOU DO NOT
KNOW TO BE USEFUL OR
BELIEVE TO BE BEAUTIFUL.”

- *William Morris*

William Morris understood design but he also understood human beings. He knew that things – possessions – only make us happy when they combine beauty with utility and vice versa. To have one without the other is unthinkable. At Bert Frank we embrace that philosophy. A table lamp or pendant is far more than a means of illumination; it is a thing of beauty to admire and touch. Equally, a lamp in the most precious materials is of no value unless it produces the lighting effects you desire. Art meets engineering. Design meets craft.

AEGIS WALL LIGHT
BRONZE OR COPPER



Aegis Wall Light Left



Aegis Wall Light Right

AGS0020 – Aegis Wall Light Left – Bronze
 AGS0021 – Aegis Wall Light Left – Copper
 AGS0022 – Aegis Wall Light Right – Bronze
 AGS0023 – Aegis Wall Light Right – Copper
 Materials = Brass, Copper
 Available in Bronze or Copper metalwork
 Brushed Brass lacquered shade as standard
 Custom finishes available
 6W / 500lm / 2700k / CRI>80
 2 x 3W LED G9-240V or E12-120V (supplied)
 LED lamp only MAX 12W
 Mains dimmable / TRIAC
 Weight = 3.5kg net, 4.5kg gross
 Standard lead time = 4 - 6 weeks

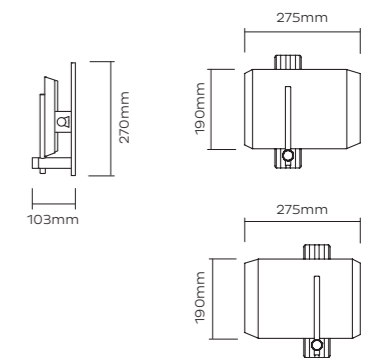

AEGIS

ARBOR

ARBOR PENDANT LIGHT SATIN BRASS

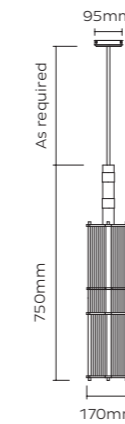

ARB0010 – Arbor Pendant Light - Satin Brass
 Materials = Brass, Acrylic
 Brushed brass as standard
 Custom finishes available
 6W / 420lm / 2700k / CRI>80
 1 x 6W LED E26-120V or E27-240V (supplied)
 Non-dimmable
 Weight = 5kg net, 6kg gross
 Standard lead time = 4 - 6 weeks
 Ceiling Canopy = Brushed brass round ceiling canopy H30 x R116mm
 Custom brass drop rod at specified length

ARBOR LINEAR PENDANT 2 SATIN BRASS

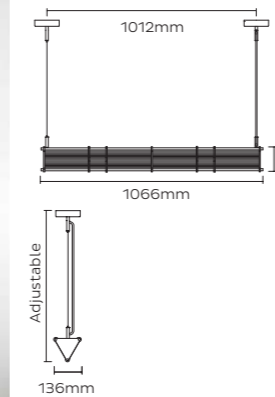

ARB0015 – Arbor Linear Pendant 2 - Satin Brass
 Materials = Brass, Acrylic
 Brushed brass as standard
 Custom finishes available
 12W / 840lm / 2700k / CRI>80
 2x 6W LED E26-120V or E27-240V (supplied)
 Non-dimmable
 Weight = 8kg net, 9kg gross
 Standard lead time = 4 - 6 weeks
 Ceiling Canopy = Brushed brass round ceiling canopy H30 x R116mm
Releasing 2022

ARBOR LINEAR PENDANT 1 SATIN BRASS

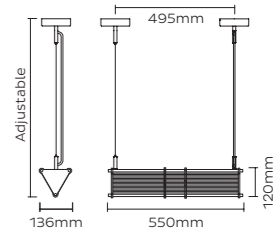

ARB0014 – Arbor Linear Pendant 1 - Satin Brass
 Materials = Brass, Acrylic
 Brushed brass as standard
 Custom finishes available
 6W / 420lm / 2700k / CRI>80
 1 x 6W LED E26-120V or E27-240V (supplied)
 Non-dimmable
 Weight = 4kg net, 5kg gross
 Standard lead time = 4 - 6 weeks
 Ceiling Canopy = Brushed brass round ceiling canopy H30 x R116mm
Releasing 2022

ARBOR LINEAR PENDANT 3 SATIN BRASS

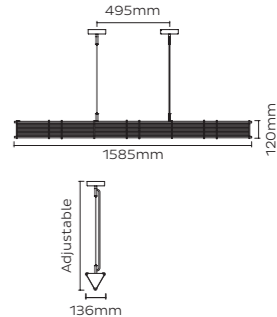

ARB0016 – Arbor Linear Pendant 3 - Satin Brass
 Materials = Brass, Acrylic
 Brushed brass as standard
 Custom finishes available
 18W / 1260lm / 2700k / CRI>80
 3x 6W LED E26-120V or E27-240V (supplied)
 Non-dimmable
 Weight = 12kg net, 13kg gross
 Standard lead time = 4 - 6 weeks
 Ceiling Canopy = Brushed brass round ceiling canopy H30 x R116mm
Releasing 2022

ARBOR LINEAR PENDANT 4
SATIN BRASS

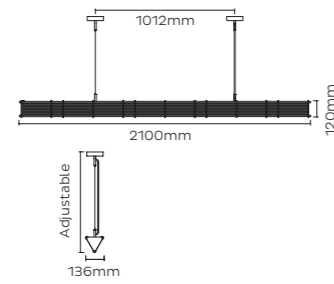

ARB0017 – Arbor Linear Pendant 4 – Satin Brass

Materials = Brass, Acrylic
Brushed brass as standard
Custom finishes available
24W / 1680lm / 2700k / CRI>80
4x 6W LED E26-120V or E27-240V (supplied)
Non-dimmable

Weight = 16kg net, 17kg gross
Standard lead time = 4 - 6 weeks

Ceiling Canopy = Brushed brass round ceiling canopy H30 x R116mm

Releasing 2022

ARBOR WALL LIGHT FLUSH
SATIN BRASS

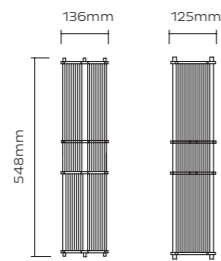

ARB0024 – Arbor Wall Light Flush – Satin Brass

Materials = Brass, Acrylic
Brushed brass as standard
Custom finishes available
6W / 420lm / 2700k / CRI>80
1x 6W LED E26-120V or E27-240V (supplied)
Non-dimmable

Weight = 5kg net, 6kg gross
Standard lead time = 4 - 6 weeks

Releasing 2022

ARBOR WALL LIGHT
SATIN BRASS

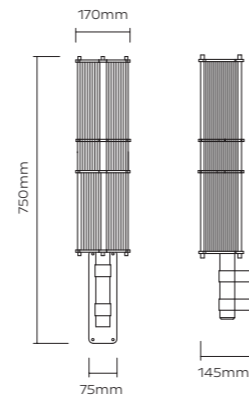

ARB0020 – Arbor Wall Light – Satin Brass

Materials = Brass, Acrylic
Brushed brass as standard
Polished Brass and Chrome custom available
6W / 420lm / 2700k / CRI>80
1x 6W LED E26-240V or E27-240V (supplied)
Mains dimmable / TRIAC

Weight = 5kg net, 6kg gross
Standard lead time = 4 - 6 weeks

ARBOR TABLE LAMP
SATIN BRASS

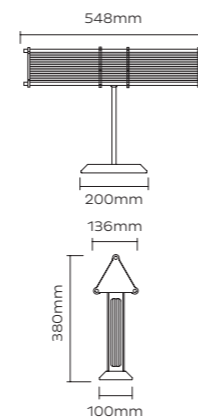

ARB0014 – Arbor Linear Pendant 1 – Satin Brass

Materials = Brass, Acrylic
Brushed brass as standard
Custom finishes available
6W / 420lm / 2700k / CRI>80
1x 6W LED E26-120V or E27-240V (supplied)
Non-dimmable

Weight = 6kg net, 7kg gross
Standard lead time = 4 - 6 weeks

Cord = 200cm fabric cord provided
Inline switch on cord

Releasing 2022



BERAN

BERAN WALL LIGHT SMALL
BRUSHED BRASS OR SATIN NICKEL

BERAN WALL LIGHT LARGE
BRUSHED BRASS OR SATIN NICKEL



BRN0020 – Beran Wall Light Small – Brass
BRN0022 – Beran Wall Light Small – Nickel
Materials = Brass, Alabaster
Metalwork lacquered as standard
6W / 700lm (source) / 2700k / CRI>90
Integrated 120/240V Mains LED
Mains dimmable / TRIAC / IP65
Weight = 4.4kg net, 6kg gross
Standard lead time = 4 – 6 weeks
Wall plate = White 120mm wall plate
89mm (3.5in) mounting template



BRN0021 – Beran Wall Light Large – Brass
BRN0023 – Beran Wall Light Large – Nickel
Materials = Brass, Alabaster
Metalwork lacquered as standard
6W / 700lm (source) / 2700k / CRI>90
Integrated 120/240V Mains LED
Mains dimmable / TRIAC / IP65
Weight = 4.4kg net, 6kg gross
Standard lead time = 4 – 6 weeks
Wall plate = White 120mm wall plate
89mm (3.5in) mounting template

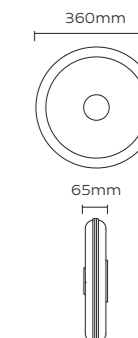

BIDE WALL LIGHT SMALL
BRUSHED BRASS OR SATIN NICKEL

BIDE WALL LIGHT LARGE
BRUSHED BRASS OR SATIN NICKEL



BDE0020 – Bide Wall Light Small – Brass
BDE0022 – Bide Wall Light Small – Nickel
Materials = Brass, Alabaster
Metalwork lacquered as standard
6W / 700lm (source) / 2700k / CRI>90
Integrated 120/240V Mains LED
Mains dimmable / TRIAC / IP65
Weight = 1.3kg net, 2.3kg gross
Standard lead time = 4 – 6 weeks
Wall plate = White 116mm wall plate
3.5in/100mm mounting template

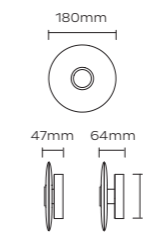

BDE0021 – Bide Wall Light Large – Brass
BDE0023 – Bide Wall Light Large – Nickel
Materials = Brass, Alabaster
Metalwork lacquered as standard
6W / 700lm (source) / 2700k / CRI>90
Integrated 120/240V Mains LED
Mains dimmable / TRIAC / IP65
Weight = 2.3kg net, 3.4kg gross
Standard lead time = 4 – 6 weeks
Wall plate = White 116mm wall plate
3.5in/100mm mounting template

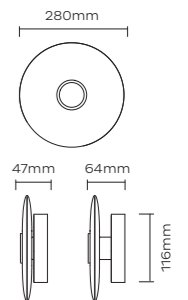

BIDE

BRACE WALL LIGHT SMALL
BRUSHED BRASS OR SATIN NICKEL



BRACE WALL LIGHT LARGE
BRUSHED BRASS OR SATIN NICKEL



BRC0020 – Brace Wall Light Small – Brass
BRC0022 – Brace Wall Light Small – Nickel
Materials = Brass, Alabaster
Available in brushed brass or nickel metalwork
Metalwork lacquered as standard
10W Integrated 12V LED
Inbuilt 120/240V CC LED driver
900lm (source) / 2700k / IP44
Mains dimmable / TRIAC
Weight = 2.5kg net, 3.5kg gross
Standard lead time = 4 - 6 weeks



BRC0021 – Brace Wall Light Large – Brass
BRC0023 – Brace Wall Light Large – Nickel
Materials = Brass, Alabaster
Available in brushed brass or nickel metalwork
Metalwork lacquered as standard
15W Integrated 12V LED
Inbuilt 120/240V CC LED driver
1375lm (source) / 2700k / IP44
Mains dimmable / TRIAC
Weight = 2.5kg net, 3.5kg gross
Standard lead time = 4 - 6 weeks



BRACE

CASK

CASK PENDANT LIGHT
BRUSHED BRASS

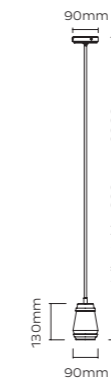

CSK0010 – Cask Pendant Light
 Materials = Brass
 Brushed Brass lacquered as standard
 3W / 250lm / 2700k / CRI>80
 1 x 3W LED G9-240V or E12-120V (supplied)
 LED lamp only MAX 12W
 Mains dimmable / TRIAC
 Weight = 1.7kg net, 2.5kg gross
 Standard lead time = 4 - 6 weeks
 Ceiling Canopy = Brushed brass round ceiling canopy
 H30 x R116mm

CASK WALL LIGHT
BRUSHED BRASS

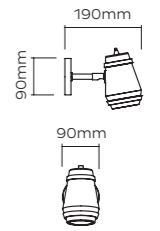

CSK0010 – Cask Pendant Light
 Materials = Brass
 Brushed Brass lacquered as standard
 3W / 250lm / 2700k / CRI>80
 1 x 3W LED G9-240V or E12-120V (supplied)
 LED lamp only MAX 12W
 Mains dimmable / TRIAC
 Weight = 2kg net, 3kg gross
 Standard lead time = 4 - 6 weeks
 Wall Plate = Brushed brass 80mm wall canopy
 as standard

CASK TABLE LAMP
BRUSHED BRASS

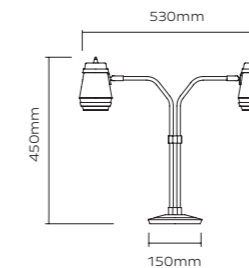

CSK0030 – Cask Table Lamp
 Materials = Brass
 Brushed Brass lacquered as standard
 6W / 500lm / 2700k / CRI>80
 2x 3W LED G9-240V or E12-120V (supplied)
 LED lamp only MAX 12W
 Mains dimmable / TRIAC
 Weight = 5.8kg net, 7kg gross
 Standard lead time = 4 - 6 weeks
 200cm fabric cord provided
 Switch on lamp (CE cert)
 Inline switch on cord (UL cert)
 5amp plug available

COLT

COLT PENDANT SINGLE BRUSHED BRASS

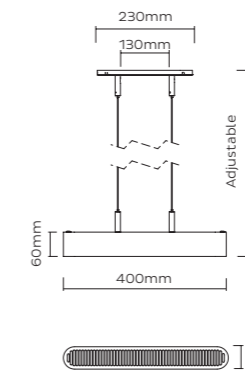

CLT0010 – Colt Pendant Single
 Materials = Brass
 Brushed Brass lacquered as standard
 15.5W / 1450lm / 2700k / CRI>80
 Integrated 24V LED module
 Mains dimmable / TRIAC
 Driver = 1 x 20W LED Integrated driver
 Weight = 4.5kg net, 5.5kg gross
 Standard lead time = 4 - 6 weeks
 Ceiling canopy =
 1 x Brushed brass canopy - 230L x 60W
 2 x Adjustable suspension cables

COLT PENDANT TRIPLE BRUSHED BRASS

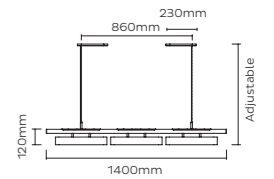

CLT0011 – Colt Pendant Triple
 Materials = Brass, Steel
 Brushed Brass lacquered as standard
 46.5W / 4350lm / 2700k / CRI>80
 3 x Integrated 24V LED module
 Mains dimmable / TRIAC
 Driver = 3 x 20W LED Integrated driver
 Weight = 12kg net, 18kg gross
 Standard lead time = 4 - 6 weeks
 Ceiling canopy =
 2 x Brushed brass canopy 230L x 60W
 2 x Adjustable suspension cables

COLT WALL LIGHT FLUSH BRUSHED BRASS

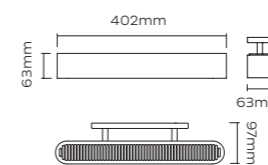

CLT0024 – Colt Wall Light Flush
 Materials = Brass
 Brushed Brass lacquered as standard
 15.5W / 1450lm / 2700k / CRI>80
 Integrated 24V LED module
 Mains dimmable / TRIAC
 Driver = 1 x 20W LED Integrated driver
 Weight = 4.2kg net, 5.5kg gross
 Standard lead time = 4 - 6 weeks
 Wall plate =
 Brushed brass wallplate - W230 x H60mm

COLT WALL LIGHT SINGLE BRUSHED BRASS

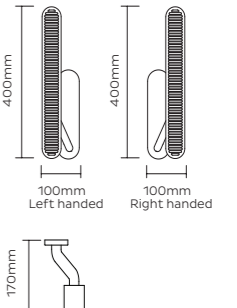

CLT0020 – Colt Wall Light Single - Left
 CLT0021 – Colt Wall Light Single - Right
 Materials = Brass
 Brushed Brass lacquered as standard
 15.5W / 1450lm / 2700k / CRI>80
 Integrated 24V LED module
 Mains dimmable / TRIAC
 Driver = 1 x 20W LED Integrated driver
 Weight = 4.2kg net, 5.5kg gross
 Standard lead time = 4 - 6 weeks
 Wall plate =
 Brushed brass wallplate - H230 x W60mm

COLT WALL LIGHT DOUBLE
BRUSHED BRASS



COLT TABLE LAMP
BRUSHED BRASS



CLT0022 - Colt Wall Light Double - Left
 CLT0023 - Colt Wall Light Double - Right
 Materials = Brass
 Brushed Brass lacquered as standard
 31W / 2900lm / 2700k / CRI>80
 2 x Integrated 24V LED module
 Mains dimmable / TRIAC
 Driver = 2 x 20W LED Integrated driver
 Weight = 7.8kg net, 10kg gross
 Standard lead time = 4 - 6 weeks
 Wall plate =
 Brushed brass wallplate -
 H230 x W60mm

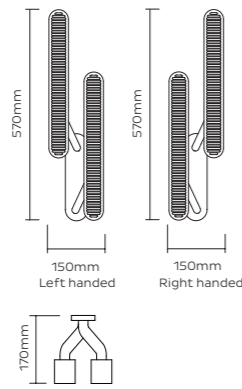

CLT0030 - Colt Table Lamp
 Materials = Brass
 Brushed Brass lacquered as standard
 15.5W / 1450lm / 2700k / CRI>80
 Integrated 24V LED module
 Mains dimmable / TRIAC
 Driver = 1 x 20W LED Integrated driver
 Weight = 6.8kg net, 8.5kg gross
 Standard lead time = 4 - 6 weeks
 Cord = 200cm fabric cord provided
 Inline switch on cord

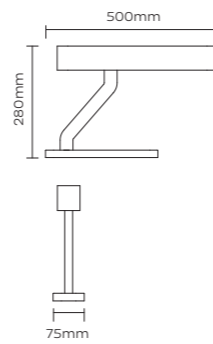



CORBEL

CORBEL TABLE LAMP
BRUSHED BRASS



COR0030 - Corbel Table Lamp - Green
COR0031 - Corbel Table Lamp - White
COR0032 - Corbel Table Lamp - Black
Materials = Brass, Marble
Polished brass lacquered as standard
Guatemalan green, Carrara white or Black Nero marble
12.2W / 1200lm / 2700k / CRI>80
Integrated 24V LED module
Mains Dimmable
Weight = 7.5kg net, 8kg gross
Standard lead time = 4 - 6 weeks
Cord = 200cm fabric cord provided
Inline switch on cord

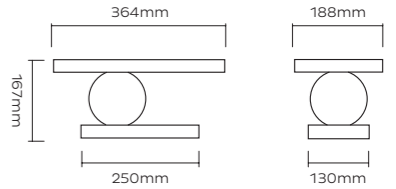

FAROL



FAROL PENDANT LIGHT OPAL OR SMOKED GLASS

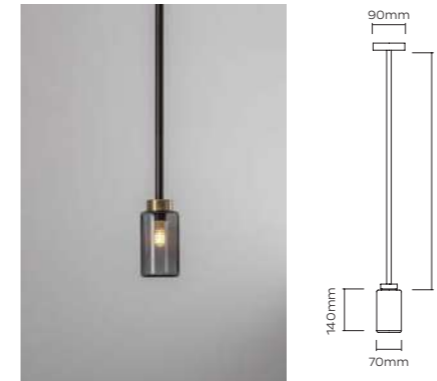

FRL0010 – Farol Pendant Light - Opal
 FRL0011 – Farol Pendant Light - Smoked
 Materials = Brass, Glass
 Bronzed brass waxed as standard
 Custom finishes available
 3W / 250lm / 2700k / CRI>80
 1 x 3W LED G9-240V or E12-120V (supplied)
 Mains dimmable / TRIAC
 Weight = 3.5kg net, 4.5kg gross
 Standard lead time = 4 - 6 weeks
 Ceiling Canopy = Brushed brass round ceiling canopy
 H30 x R120mm
 Custom brass drop rod at specified length

FAROL WALL LIGHT DOUBLE OPAL OR SMOKED GLASS

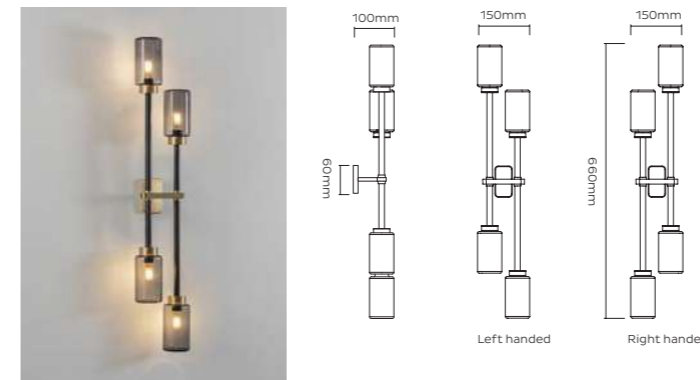

FRL0022 – Farol Wall Left Double - Opal
 FRL0023 – Farol Wall Left Double - Smoked
 FRL0024 – Farol Wall Right Double - Opal
 FRL0025 – Farol Wall Right Double - Smoked
 Materials = Brass, Glass
 Bronzed brass waxed as standard
 Custom finishes available
 12W / 1000lm / 2700k / CRI>80
 4 x 3W LED G9-240V or E12-120V (supplied)
 Mains dimmable / TRIAC / IP20
 Weight = 3.5kg net, 4.5kg gross
 Standard lead time = 4 - 6 weeks
 Wall Bracket = Brushed brass wall bracket
 H90 x W50mm

FAROL WALL LIGHT SINGLE OPAL OR SMOKED GLASS

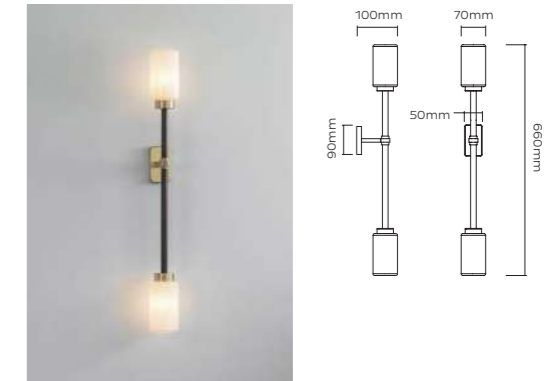

FRL0020 – Farol Wall Light Single - Opal
 FRL0021 – Farol Wall Light Single - Smoked
 Materials = Brass, Glass
 Bronzed brass waxed as standard
 Custom finishes available
 6W / 500lm / 2700k / CRI>80
 2 x 3W LED G9-240V or E12-120V (supplied)
 Mains dimmable / TRIAC / IP20
 Weight = 2.35kg net, 2.5kg gross
 Standard lead time = 4 - 6 weeks
 Wall Bracket = Brushed brass wall bracket
 H90 x W50mm

FLAGON

FLAGON PENDANT BRUSHED BRASS



FLG0010 – Flagon Pendant Light
 Materials = Brass
 Brushed Brass lacquered and black detailing as standard
 Custom finishes available
 3W / 250lm / 2700k / CRI>80
 1 x 3W LED G9-240V or E12-120V (supplied)
 Mains dimmable / TRIAC
 Weight = 1.5kg net, 2kg gross
 Standard lead time = 4 - 6 weeks
 Ceiling Canopy = Brushed brass round ceiling canopy H30 x R116mm
 Adjustable 200cm fabric cord provided

FLAGON CLUSTER 3 BRUSHED BRASS

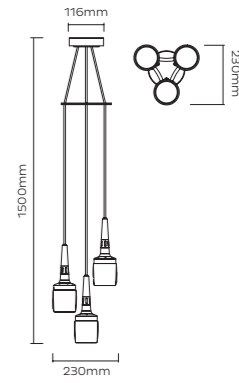

FLG0011 – Flagon Cluster 3
 Materials = Brass
 Brushed Brass lacquered and black detailing as standard
 Custom finishes available
 9W / 750lm / 2700k / CRI>80
 3 x 3W LED G9-240V or E12-120V (supplied)
 Mains dimmable / TRIAC
 Weight = 6kg net, 7kg gross
 Standard lead time = 4 - 6 weeks
 Ceiling Canopy = Brushed brass round ceiling canopy H30 x R120mm
 Adjustable 200cm fabric cord provided

FLAGON CLUSTER 5 BRUSHED BRASS

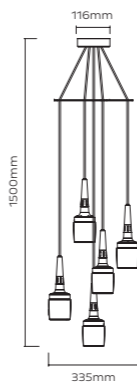

FLG0012 – Flagon Cluster 5
 Materials = Brass
 Brushed Brass lacquered and black detailing as standard
 Custom finishes available
 15W / 1250lm / 2700k / CRI>80
 5 x 3W LED G9-240V or E12-120V (supplied)
 Mains dimmable / TRIAC
 Weight = 8kg net, 9kg gross
 Standard lead time = 4 - 6 weeks
 Ceiling Canopy = Brushed brass round ceiling canopy H30 x R120mm
 Adjustable 200cm fabric cord provided

FLAGON CHANDELIER 10 BRUSHED BRASS

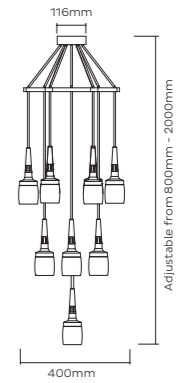

FLG0013 – Flagon Chandelier 10
 Materials = Brass
 Brushed Brass lacquered and black detailing as standard
 Custom finishes available
 30W / 2500lm / 2700k / CRI>80
 10 x 3W LED G9-240V or E12-120V (supplied)
 Mains dimmable / TRIAC
 Weight = 16kg net, 18kg gross
 Standard lead time = 4 - 6 weeks
 Ceiling Canopy = Brushed brass round ceiling canopy H30 x R120mm
 Adjustable 200cm fabric cord provided



GLAIVE

GLAIVE PENDANT LIGHT BRUSHED BRASS

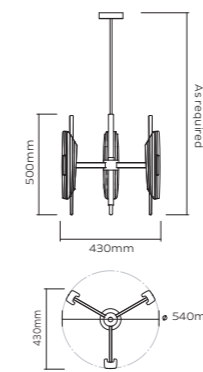

GLV0010 – Glaive pendant Light
 Materials = Brass, Fine Bone China
 Brushed Brass lacquered as standard
 Custom finishes available
 18W / 1500lm / 2700k / CRI>80
 6 x 3W LED G9-240V or E12-120V (supplied)
 Mains dimmable / TRIAC
 Weight = 8kg net, 10kg gross
 Standard lead time = 4 - 6 weeks
 Ceiling Canopy = Brushed brass round ceiling canopy H30 x R116mm
 Custom brass drop rod at specified length

GLAIVE WALL LIGHT SINGLE BRUSHED BRASS

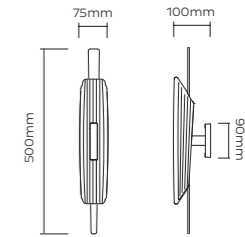

GLV0020 – Glaive Wall Light Single
 Materials = Brass, Fine Bone China
 Brushed Brass lacquered as standard
 Custom finishes available
 6W / 500lm / 2700k / CRI>80
 2 x 3W LED G9-240V or E12-120V (supplied)
 Mains dimmable / TRIAC
 Weight = 1.6kg net, 2kg gross
 Standard lead time = 4 - 6 weeks
 Wall Bracket = Brushed brass wall bracket H90 x W50mm

GLAIVE WALL LIGHT DOUBLE BRUSHED BRASS

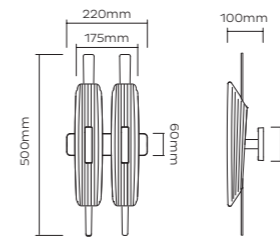

GLV0021 – Glaive Wall Light Double
 Materials = Brass, Fine Bone China
 Brushed Brass lacquered as standard
 Custom finishes available
 12W / 1000lm / 2700k / CRI>80
 4 x 3W LED G9-240V or E12-120V (supplied)
 Mains dimmable / TRIAC
 Weight = 3.5kg net, 4.2kg gross
 Standard lead time = 4 - 6 weeks
 Wall Bracket = Brushed brass wall bracket H60 x W220mm
Releases 2022

GLAIVE TABLE LAMP BRUSHED BRASS

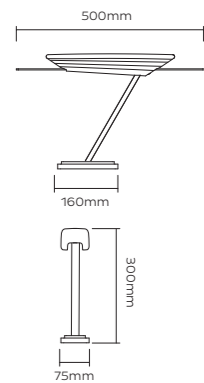

GLV0030 – Glaive Table Lamp
 Materials = Brass, Fine Bone China
 Brushed Brass lacquered as standard
 Custom finishes available
 6W / 500lm / 2700k / CRI>80
 2 x 3W LED G9-240V or E12-120V (supplied)
 Mains dimmable / TRIAC
 Weight = 3.5kg net, 4.4kg gross
 Standard lead time = 4 - 6 weeks
 Cord = 200cm fabric cord provided
 Inline switch on cord



KERNEL

KERNEL PENDANT LIGHT BRUSHED BRASS

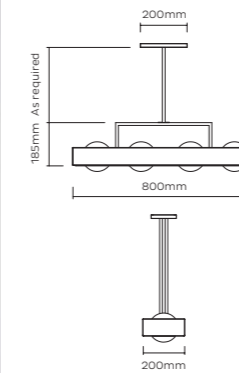

KNL0010 – Kernel Pendant Light - Black
 KNL0011 – Kernel Pendant Light - Blue
 KNL0012 – Kernel Pendant Light - White
 KNL0013 – Kernel Pendant Light - Oxblood
 Materials = Brass, Aluminium, Glass
 Brushed Brass lacquered as standard
 12W / 1000lm / 2700k / CRI>80
 4 x 3W LED G9-240V or E12-120V (supplied)
 Mains dimmable / TRIAC
 Weight = 6.5kg net, 7.2kg gross
 Standard lead time = 4 - 6 weeks
 Ceiling Canopy = Brushed brass ceiling canopy
 L200 x W 76 x H20mm
 Custom brass drop rod at specified length

KERNEL PENDANT LIGHT XL BRUSHED BRASS

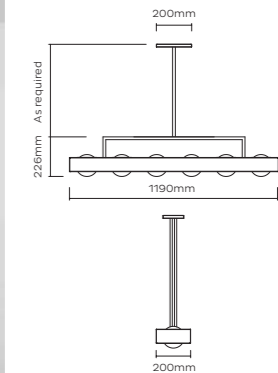

KNL0015 – Kernel Pendant Light XL - Black
 KNL0016 – Kernel Pendant Light XL - Blue
 KNL0017 – Kernel Pendant Light XL - White
 KNL0018 – Kernel Pendant Light XL - Oxblood
 Materials = Brass, Aluminium, Glass
 Brushed Brass lacquered as standard
 18W / 1500lm / 2700k / CRI>80
 6 x 3W LED G9-240V or E12-120V (supplied)
 Mains dimmable / TRIAC
 Weight = 15kg net, 18kg gross
 Standard lead time = 4 - 6 weeks
 Ceiling Canopy = Brushed brass ceiling canopy
 L200 x W 76 x H20mm
 Custom brass drop rod at specified length

KERNEL TABLE LAMP BRUSHED BRASS

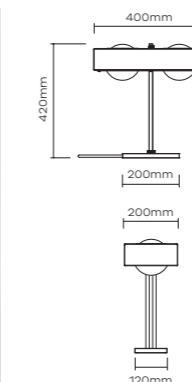

KNL0030 – Kernel Table Lamp - Black
 KNL0031 – Kernel Table Lamp - Blue
 KNL0032 – Kernel Table Lamp - White
 KNL0033 – Kernel Table Lamp - Oxblood
 Materials = Brass, Aluminium, Glass
 Brushed Brass lacquered as standard
 6W / 500lm / 2700k / CRI>80
 2 x 3W LED G9-240V or E12-120V (supplied)
 Mains dimmable / TRIAC
 Weight = 6kg net, 7.5kg gross
 Standard lead time = 4 - 6 weeks
 Cord = 200cm fabric cord provided
 Inline switch on cord

KERNEL FLOOR LAMP BRUSHED BRASS

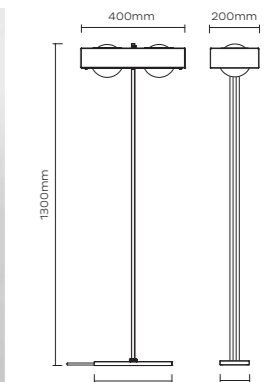

KNL0040 – Kernel Floor Lamp - Black
 KNL0041 – Kernel Floor Lamp - Blue
 KNL0042 – Kernel Floor Lamp - White
 KNL0043 – Kernel Table Lamp - Oxblood
 Materials = Brass, Aluminium, Glass
 Brushed Brass lacquered as standard
 6W / 500lm / 2700k / CRI>80
 2 x 3W LED G9-240V or E12-120V (supplied)
 Mains dimmable / TRIAC
 Weight = 13.5kg net, 18kg gross
 Standard lead time = 4 - 6 weeks
 Cord = 200cm fabric cord provided
 Inline foot switch on cord

KINS



KINS PENDANT LIGHT
BRUSHED BRASS



KINS WALL LIGHT
BRUSHED BRASS



KNS0010 – Kins Pendant Light - Black
KNS0011 – Kins Pendant Light - White
Materials = Brass, Aluminium, Glass.
Brushed Brass lacquered as standard
3W / 250lm / 2700k / CRI>80
1x 3W LED G9-240V or E12-120V (supplied)
Mains dimmable / TRIAC
Weight = 4kg net, 5kg gross
Standard lead time = 4 - 6 weeks
Ceiling Canopy = Brushed brass round
ceiling canopy H30 x R116mm
Custom brass drop rod at specified length

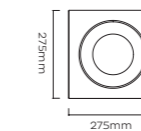
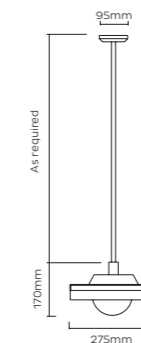

KNS0020 – Kins Wall Light - Black
KNS0021 – Kins Wall Light - White
Materials = Brass, Aluminium, Glass.
Brushed Brass lacquered as standard
3W / 250lm / 2700k / CRI>80
1x 3W LED G9-240V or E12-120V (supplied)
Mains dimmable / TRIAC
Weight = 4kg net, 5kg gross
Standard lead time = 4 - 6 weeks
Wall Plate = 124mm round wall plate

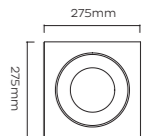

LIZAK

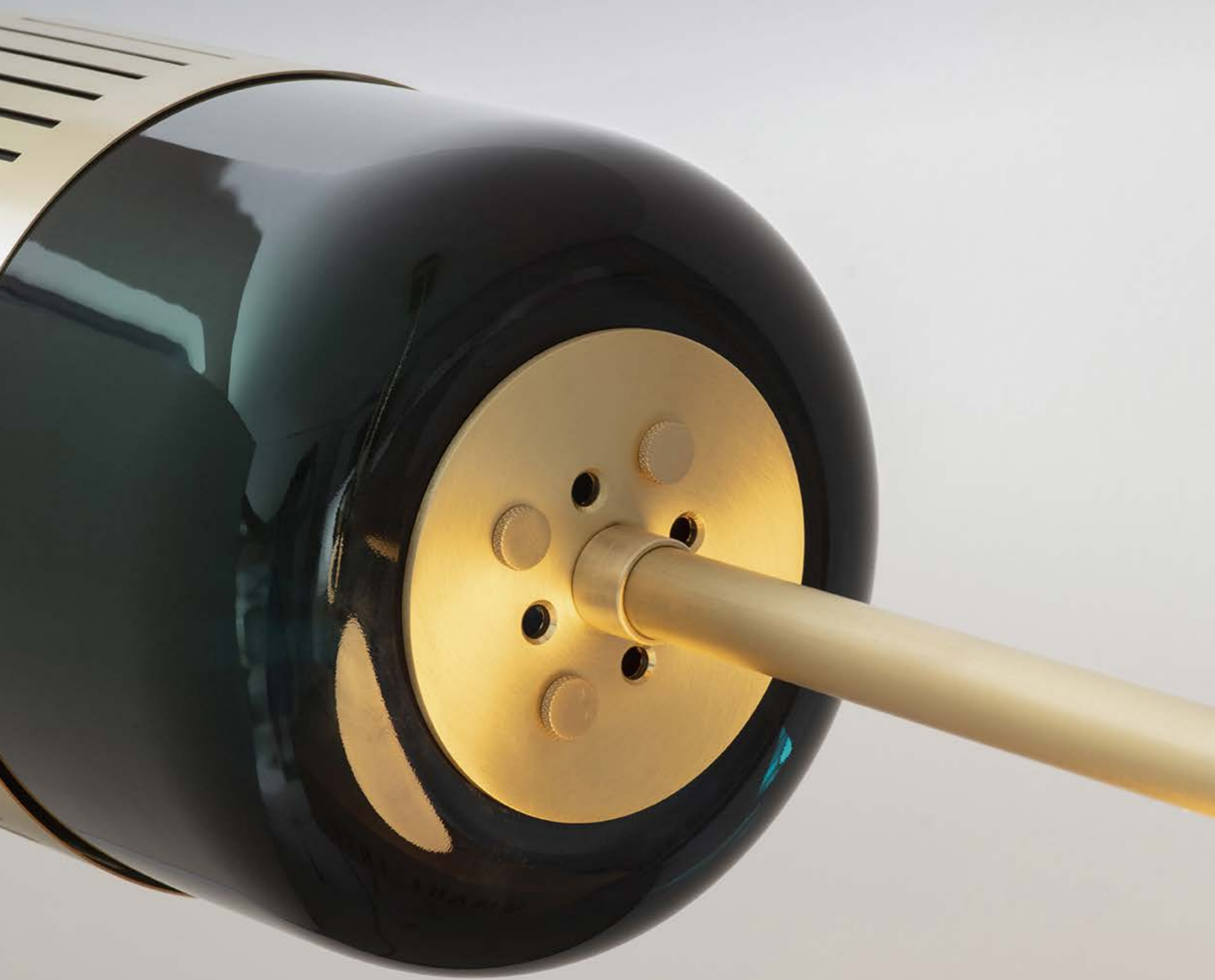

LIZAK DROP PENDANT LIGHT BRUSHED OR BRONZED BRASS

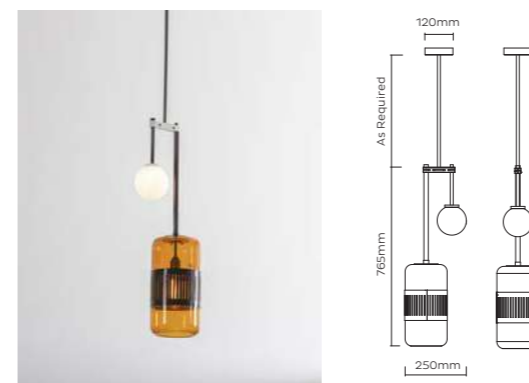

LSK0013 – Lizak Drop Pendant Light - Peacock / Brass
 LSK0014 – Lizak Drop Pendant Light - Smoked / Brass
 LSK0015 – Lizak Drop Pendant Light - Amber / Bronze

Materials = Brass, Aluminium, Glass
 Brushed brass lacquered w/ black detail
 Bronzed brass waxed w/ white detail

>3W / >250lm / 2700k / CRI>80
 1 x 3W LED G9-240V or E12-120V (supplied)
 1 x E27/26 LED filament lamp (not supplied)
 Mains dimmable / TRIAC

Weight = 4.8kg net, 5.8kg gross
 Standard lead time = 4 - 6 weeks

Ceiling Canopy = Brushed brass round ceiling canopy
 H30 x R116mm

Custom brass drop rod at specified length

LIZAK FLOOR LAMP BRUSHED OR BRONZED BRASS

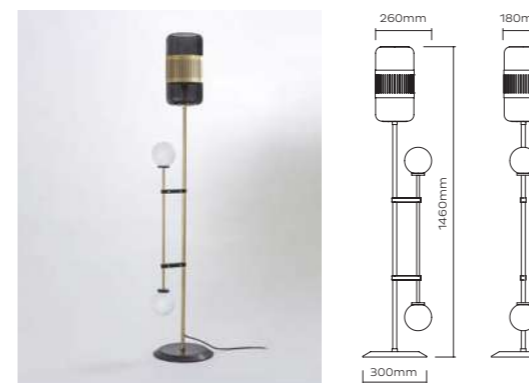

LSK0040 – Lizak Floor Lamp - Peacock / Brass
 LSK0041 – Lizak Floor Lamp - Smoked / Brass
 LSK0042 – Lizak Floor Lamp - Amber / Bronze

Materials = Brass, Aluminium, Glass, Marble
 Brushed brass lacquered w/ black detail
 Bronzed brass waxed w/ white detail

>6W / >500lm / 2700k / CRI>80
 2 x 3W LED G9-240V or E12-120V (supplied)
 1 x E27/26 LED filament lamp (not supplied)
 Mains dimmable / TRIAC available

Weight = 10kg net, 18kg gross
 Standard lead time = 4 - 6 weeks

Cord = 200cm fabric cord provided
 Inline switch on cord

LIZAK PENDANT LIGHT BRUSHED OR BRONZED BRASS

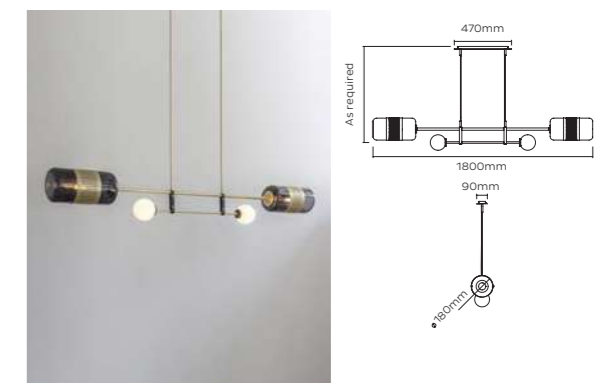

LSK0010 – Lizak Pendant Light - Peacock / Brass
 LSK0011 – Lizak Pendant Light - Smoked / Brass
 LSK0012 – Lizak Pendant Light - Amber / Bronze

Materials = Brass, Aluminium, Glass
 Brushed brass lacquered w/ black detail
 Bronzed brass waxed w/ white detail

>6W / >500lm / 2700k / CRI>80
 2 x 3W LED G9-240V or E12-120V (supplied)
 2 x E27/26 LED filament lamp (not supplied)
 Mains dimmable / TRIAC

Weight = 12.5kg net, 16kg gross
 Standard lead time = 4 - 6 weeks

Ceiling Canopy = Brushed brass ceiling canopy
 L470 x W90 x H20mm

2 x Adjustable suspension cables

OR

Custom brass drop rod at specified length



MASINA PENDANT LIGHT
BRUSHED BRASS

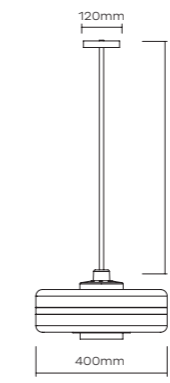

MSN0010 – Masina Pendant Light
Materials = Brass, Steel, Glass
Brushed Brass lacquered as standard
1 x LED E27/26 lamp (not supplied)
Mains dimmable / TRIAC / IP20
Weight = 8kg net, 9kg gross
Standard lead time = 4 - 6 weeks
Ceiling Canopy = Brushed brass round ceiling canopy H30 x R116mm
Custom brass drop rod at specified length

MASINA WALL LIGHT
BRUSHED BRASS

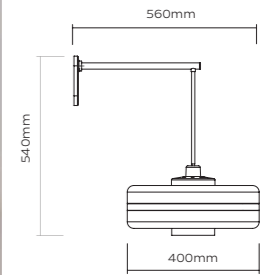

MSN0020 – Masina Wall Light
Materials = Brass, Steel, Glass
Brushed Brass lacquered as standard
1 x LED E27/26 lamp (not supplied)
Mains dimmable / TRIAC / IP20
8kg net, 10kg gross
Standard lead time = 4 - 6 weeks
Wall Plate = Brushed brass wall plate H150 x W60mm

MASINA TABLE LAMP
BRUSHED BRASS

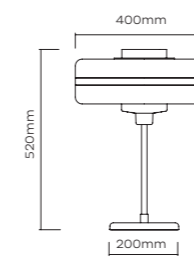

MSN0030 – Masina Table Lamp
Materials = Brass, Steel, Glass
Brushed Brass lacquered as standard
1 x LED E27/26 lamp (not supplied)
Mains dimmable / TRIAC / IP20
10kg net, 12kg gross
Standard lead time = 4 - 6 weeks
Cord = 200cm fabric cord provided
Inline switch on cord

MASINA FLOOR LAMP
BRUSHED BRASS

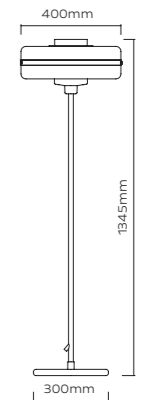

MSN0040 – Masina Floor Lamp
Materials = Brass, Steel, Glass
Brushed Brass lacquered as standard
1 x LED E27/26 lamp (not supplied)
Mains dimmable / TRIAC / IP20
16kg net, 20kg gross
Standard lead time = 4 - 6 weeks
Cord = 200cm fabric cord provided
Inline foot switch on cord

MASINA

OCCULO



OCCULO PENDANT LIGHT

BRUSHED BRASS, BRONZED BRASS OR NICKEL

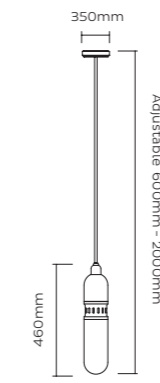

OCC0010 - Occulo Pendant Light, Brushed Brass
 OCC0011 - Occulo Pendant Light, Dark Bronze
 OCC0012 - Occulo Pendant Light, Satin Nickel

Materials = Brass, Glass
 Brushed Brass lacquered as standard

6W / 400lm / 2700k / CRI>80
 1 x LED E27/26 T-30 lamp (supplied)
 non-dimmable / IP20

Weight = 2.5kg net, 3kg gross
 Standard lead time = 4 - 6 weeks

Ceiling Canopy = Brushed brass round ceiling canopy H30 x R116mm

OCCULO WALL LIGHT

BRUSHED BRASS, BRONZED BRASS OR NICKEL

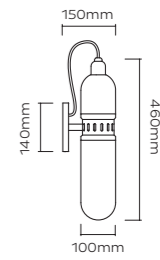

OCC0020 - Occulo Wall Light, Brushed Brass
 OCC0021 - Occulo Wall Light, Dark Bronze
 OCC0022 - Occulo Wall Light, Satin Nickel

Materials = Brass, Glass
 Brushed Brass lacquered as standard

6W / 400lm / 2700k / CRI>80
 1 x LED E27/26 T-30 lamp (supplied)
 non-dimmable / IP20

Weight = 2.6kg net, 3kg gross
 Standard lead time = 4 - 6 weeks

Wall Plate = Brass/Bronzed wall plate H140 x W60mm

OCCULO SIDE TABLE LAMP

BRUSHED BRASS, BRONZED BRASS OR NICKEL

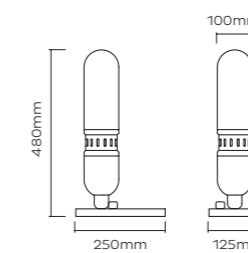

OCC0030 - Occulo Table Lamp, Brushed Brass
 OCC0031 - Occulo Table Lamp, Dark Bronze
 OCC0032 - Occulo Table Lamp, Satin Nickel

Materials = Brass, Glass
 Brushed Brass lacquered as standard

6W / 400lm / 2700k / CRI>80
 1 x LED E27/26 T-30 lamp (supplied)
 non-dimmable / IP20

Weight = 2.5kg net, 3kg gross
 Standard lead time = 4 - 6 weeks

Cord = 200cm fabric cord provided
 Inline switch on cord

OCCULO TABLE LAMP

BRUSHED BRASS, BRONZED BRASS OR NICKEL

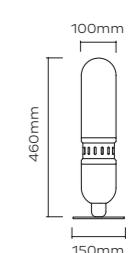

OCC0035 - Occulo Side Table Lamp, Brushed Brass
 OCC0036 - Occulo Side Table Lamp, Dark Bronze
 OCC0037 - Occulo Side Table Lamp, Satin Nickel

Materials = Brass, Glass
 Brushed Brass lacquered as standard

6W / 400lm / 2700k / CRI>80
 1 x LED E27/26 T-30 lamp (supplied)
 non-dimmable / IP20

Weight = 2.5kg net, 3kg gross
 Standard lead time = 4 - 6 weeks

Cord = 200cm fabric cord provided
 Switch on base

OCCULO FLOOR LAMP
BRUSHED BRASS



OCC0040 – Occulo Floor Lamp
Materials = Brass, Glass
Brushed Brass lacquered as standard
6W / 400lm / 2700k / CRI>80
1 x LED E27/26 T-30 lamp (supplied)
non-dimmable / IP20
Weight = 11.5kg net, 12.5kg gross
Standard lead time = 4 - 6 weeks
Cord = 200cm fabric cord provided
Inline foot switch on cord

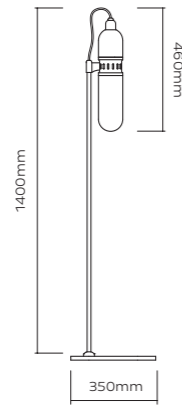

PENNON PENDANT LIGHT
BRUSHED BRASS OR BRONZED BRASS

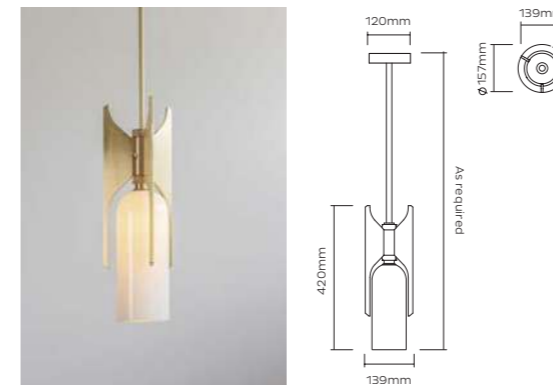

PNN0010 – Pennon Pendant Light – Brass
PNN0011 – Pennon Pendant Light – Bronze

Materials = Brass, Fine bone china
Brushed brass w/ polished brass edge
Bronzed brass w/ brushed brass edge
3W / 250lm / 2700k / CRI>80
1 x 3W LED G9-240V or E12-120V (supplied)
Mains dimmable / TRIAC
Weight = 4kg net, 5kg gross
Standard lead time = 4 - 6 weeks
Ceiling Canopy = Brushed brass round ceiling canopy H30 x R116mm
Custom brass drop rod at specified length

PENNON TABLE LAMP
BRUSHED BRASS OR BRONZED BRASS



PNN0030 – Pennon Table Lamp – Brass
PNN0031 – Pennon Table Lamp – Bronze

Materials = Brass, Fine bone china
Brushed brass w/ polished brass edge
Bronzed brass w/ brushed brass edge
3W / 250lm / 2700k / CRI>80
1 x 3W LED G9-240V or E12-120V (supplied)
Mains dimmable / TRIAC
Weight = 3kg net, 4kg gross
Standard lead time = 4 - 6 weeks
Cord = 200cm fabric cord provided
Inline switch on cord

PENNON WALL LIGHT
BRUSHED BRASS OR BRONZED BRASS

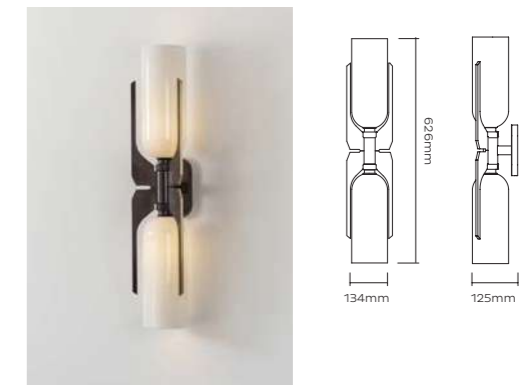

PNN0020 – Pennon Wall – Brass
PNN0021 – Pennon Wall – Bronze

Materials = Brass, Fine bone china
Brushed brass w/ polished brass edge
Bronzed brass w/ brushed brass edge
6W / 500lm / 2700k / CRI>80
2 x 3W LED G9-240V or E12-120V (supplied)
Mains dimmable / TRIAC
Weight = 4kg net, 5kg gross
Standard lead time = 4 - 6 weeks
Wall Plate = Brass/Bronzed wall plate
H140 x W60mm

PENNON FLOOR LAMP
BRUSHED BRASS OR BRONZED BRASS



PNN0040 – Pennon Floor Lamp – Brass
PNN0041 – Pennon Floor Lamp – Bronze

Materials = Brass, Fine bone china
Brushed brass w/ polished brass edge
Bronzed brass w/ brushed brass edge
3W / 250lm / 2700k / CRI>80
1 x 3W LED G9-240V or E12-120V (supplied)
Mains dimmable / TRIAC
Weight = 5kg net, 6kg gross
Standard lead time = 4 - 6 weeks
Cord = 200cm fabric cord provided
Inline foot switch on cord

PENNON

PUGIL FLOOR LAMP
BRUSHED BRASS



PGL0040 – Pugil Floor Lamp
 Materials = Brass, Fabric
 Brushed brass lacquered as standard
 Ivory fabric shades
 6x LED E27/26 lamp (not supplied)
 Mains dimmable / TRIAC available
 Weight = 9.5kg net, 11kg gross
 Standard lead time = 4 - 6 weeks
 Cord = 200cm fabric cord provided
 Inline switch on cord

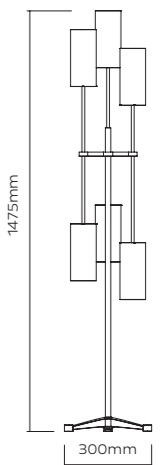

PUGIL

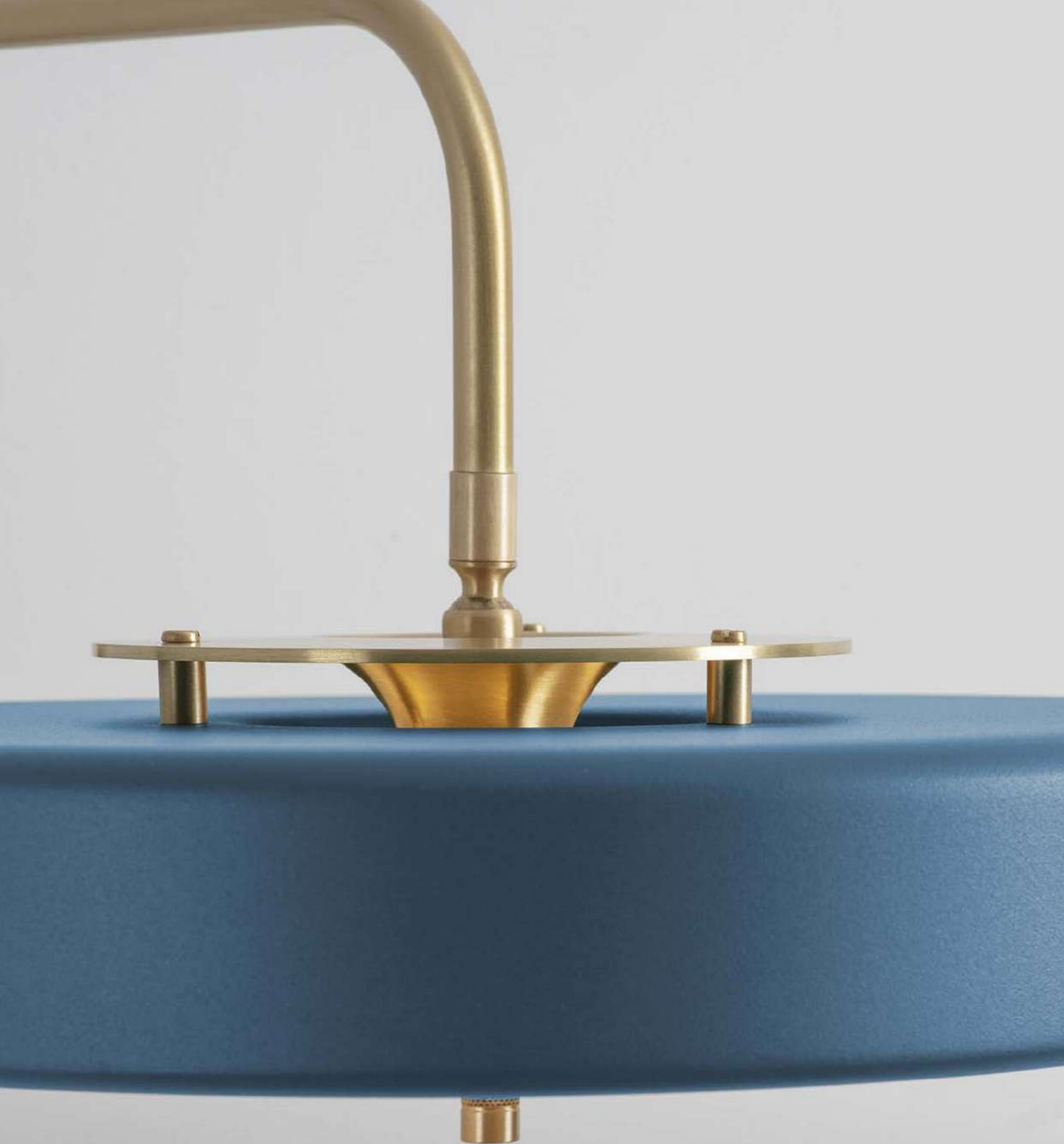

REVOLVE

REVOLVE PENDANT LIGHT BRUSHED BRASS



RVL0010 – Revolve Pendant Lamp - Black
 RVL0011 – Revolve Pendant Lamp - Blue
 RVL0012 – Revolve Pendant Lamp - White
 RVL0013 – Revolve Pendant Lamp - Green
 RVL0014 – Revolve Pendant Lamp - Oxblood
 Materials = Brass, Aluminium, Polycarbonate
 9W / 750lm / 2700k / CRI>80
 3 x 3W LED G9-240V or E12-120V (supplied)
 Mains dimmable / TRIAC
 Weight = 4kg net, 4.5kg gross
 Standard lead time = 4 - 6 weeks
 Ceiling Canopy = Brushed brass round ceiling canopy H30 x R116mm

REVOLVE RISE & FALL BRUSHED BRASS

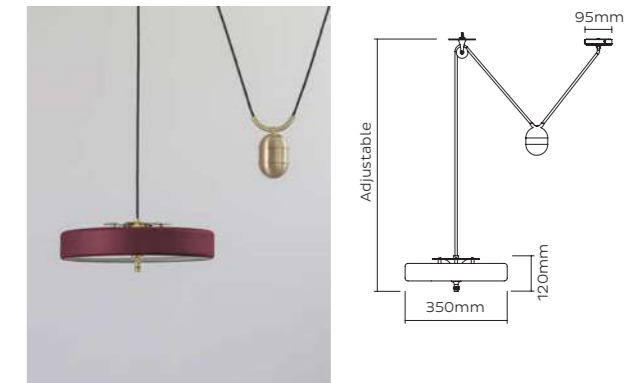

RVL0090 – Revolve Rise & Fall - Black
 RVL0091 – Revolve Rise & Fall - Blue
 RVL0092 – Revolve Rise & Fall - White
 RVL0093 – Revolve Rise & Fall - Green
 RVL0094 – Revolve Rise & Fall - Oxblood
 Materials = Brass, Aluminium, Polycarbonate
 9W / 750lm / 2700k / CRI>80
 3 x 3W LED G9-240V or E12-120V (supplied)
 Mains dimmable / TRIAC
 Weight = 8kg net, 9kg gross
 Standard lead time = 4 - 6 weeks
 Ceiling Canopy = Brushed brass round ceiling canopy H30 x R116mm

REVOLVE WALL LIGHT BRUSHED BRASS

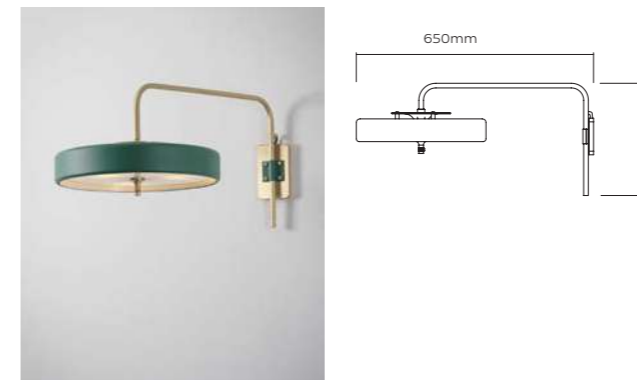

RVL0020 – Revolve Wall - Black
 RVL0021 – Revolve Wall - Blue
 RVL0022 – Revolve Wall - White
 RVL0023 – Revolve Wall - Green
 RVL0024 – Revolve Wall - Oxblood
 Materials = Brass, Aluminium, Polycarbonate
 9W / 750lm / 2700k / CRI>80
 3 x 3W LED G9-240V or E12-120V (supplied)
 Mains dimmable / TRIAC
 Weight = 5.7kg net, 6.5kg gross
 Standard lead time = 4 - 6 weeks
 Wall Plate = Brass wall plate H130 x W75mm

REVOLVE TABLE LAMP BRUSHED BRASS

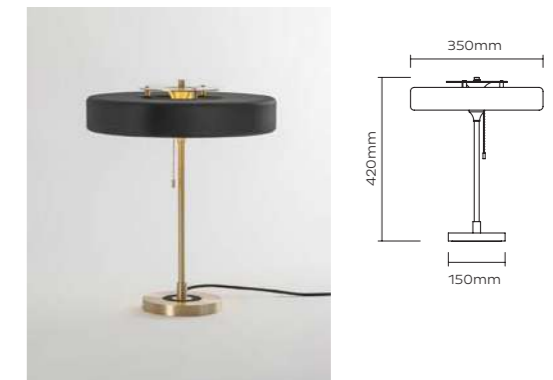

RVL0030 – Revolve Table Lamp - Black
 RVL0031 – Revolve Table Lamp - Blue
 RVL0032 – Revolve Table Lamp - White
 RVL0033 – Revolve Table Lamp - Green
 RVL0034 – Revolve Table Lamp - Oxblood
 Materials = Brass, Aluminium, Polycarbonate
 9W / 750lm / 2700k / CRI>80
 3 x 3W LED G9-240V or E12-120V (supplied)
 Mains dimmable / TRIAC
 Weight = 7kg net, 7.6kg gross
 Standard lead time = 4 - 6 weeks
 Cord = 200cm fabric cord provided
 Pull chain switch on lamp

REVOLVE FLOOR LAMP
BRUSHED BRASS



REVOLVE STEM FLOOR LAMP
BRUSHED BRASS



RVL0040 - Revolve Floor Lamp - Black
RVL0041 - Revolve Floor Lamp - Blue
RVL0042 - Revolve Floor Lamp - White
RVL0043 - Revolve Floor Lamp - Green
RVL0044 - Revolve Floor Lamp - Oxblood

Materials = Brass, Aluminium,
Polycarbonate

9W / 750lm / 2700k / CRI>80
3 x 3W LED G9-240V or E12-120V
(supplied)

Weight = 26.5kg net, 28kg gross
Standard lead time = 4 - 6 weeks
Cord = 200cm fabric cord provided
Inline foot switch on cord



RVL0060 - Revolve Floor Lamp - Black
RVL0061 - Revolve Floor Lamp - Blue
RVL0062 - Revolve Floor Lamp - White
RVL0063 - Revolve Floor Lamp - Green
RVL0064 - Revolve Floor Lamp - Oxblood

Materials = Brass, Aluminium,
Polycarbonate

9W / 750lm / 2700k / CRI>80
3 x 3W LED G9-240V or E12-120V
(supplied)

Weight = 8.5kg net, 10kg gross
Standard lead time = 4 - 6 weeks
Cord = 200cm fabric cord provided
Pull chain switch on lamp

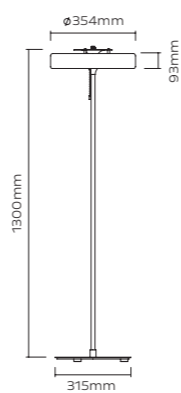



RIDDLE

RIDDLE PENDANT
BRUSHED BRASS OR BLACK POWDERCOAT



RDL0010 – Riddle Pendant Light - Brass w/ Black
RDL0011 – Riddle Pendant Light - Black w/ Brass
Materials = Brass
Brushed brass lacquered, Black textured powdercoat. Custom finishes available.
3W / 250lm / 2700k / CRI>80
1 x 3W LED G9-240V or E12-120V (supplied)
Mains dimmable / TRIAC
Weight = 1.8kg net, 2.5kg gross
Standard lead time = 4 - 6 weeks
Ceiling Canopy = Brushed brass round ceiling canopy H30 x R116mm
Adjustable 200cm fabric cord provided

RIDDLE 5 CLUSTER
BRUSHED BRASS OR BLACK POWDERCOAT



RDL0080 – Riddle 5 Cluster Light - Brass w/ Black
RDL0081 – Riddle 5 Cluster Light - Black w/ Brass
Materials = Brass
Brushed brass lacquered, Black textured powdercoat. Custom finishes available.
15W / 1250lm / 2700k / CRI>80
5 x 3W LED G9-240V or E12-120V (supplied)
Mains dimmable / TRIAC
Weight = 5kg net, 6kg gross
Standard lead time = 4 - 6 weeks
Ceiling Canopy = Brushed brass round ceiling canopy H30 x R116mm
Adjustable 200cm fabric cord provided

RIDDLE 3 CLUSTER
BRUSHED BRASS OR BLACK POWDERCOAT



RDL0070 – Riddle 3 Cluster Light - Brass w/ Black
RDL0071 – Riddle 3 Cluster Light - Black w/ Brass
Materials = Brass
Brushed brass lacquered, Black textured powdercoat. Custom finishes available.
9W / 750lm / 2700k / CRI>80
3 x 3W LED G9-240V or E12-120V (supplied)
Mains dimmable / TRIAC
Weight = 5kg net, 6kg gross
Standard lead time = 4 - 6 weeks
Ceiling Canopy = Brushed brass round ceiling canopy H30 x R116mm
Adjustable 200cm fabric cord provided

RIDDLE SINGLE WALL LIGHT
BRUSHED BRASS OR BLACK POWDERCOAT



RDL0020 – Riddle Wall Light - Brass w/ Black
RDL0021 – Riddle Wall Light - Black w/ Brass
Materials = Brass
Brushed brass lacquered, Black textured powdercoat. Custom finishes available.
3W / 250lm / 2700k / CRI>80
1 x 3W LED G9-240V or E12-120V (supplied)
Mains dimmable / TRIAC
Weight = 2kg net, 3kg gross
Standard lead time = 4 - 6 weeks
Wall Plate = Brushed brass 80mm wall plate as standard

RIDDLE DOUBLE WALL LIGHT
BRUSHED BRASS

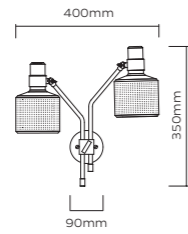

RDL0021 – Riddle Double Wall Light
Materials = Brass
Brushed brass lacquered, Black textured powdercoat. Custom finishes available.
6W / 500lm / 2700k / CRI>80
2 x 3W LED G9-240V or E12-120V (supplied)
Mains dimmable / TRIAC
Weight = 5kg net, 6kg gross
Standard lead time = 4 - 6 weeks
Wall Plate = Brushed brass 80mm wall plate as standard

RIDDLE SINGLE TABLE LAMP
BRUSHED BRASS

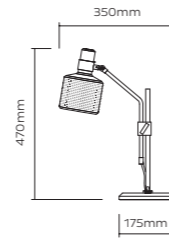

RDL0030 – Riddle Single Table Lamp
Materials = Brass
Brushed brass lacquered, Black textured powdercoat. Custom finishes available.
3W / 250lm / 2700k / CRI>80
1 x 3W LED G9-240V or E12-120V (supplied)
Mains dimmable / TRIAC (available)
Weight = 1.8kg net, 2.5kg gross
Standard lead time = 4 - 6 weeks
Cord = 200cm fabric cord provided
Toggle switch on base

RIDDLE DOUBLE FLOOR LAMP
BRUSHED BRASS

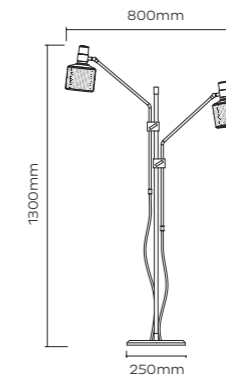

RDL0041 – Riddle Double Floor Lamp
Materials = Brass
Brushed brass lacquered, Black textured powdercoat. Custom finishes available.
6W / 500lm / 2700k / CRI>80
2 x 3W LED G9-240V or E12-120V (supplied)
Mains dimmable / TRIAC (available)
Weight = 18kg net, 20kg gross
Standard lead time = 4 - 6 weeks
Cord = 200cm fabric cord provided
Inline foot switch on cord

RIDDLE DOUBLE TABLE LAMP
BRUSHED BRASS

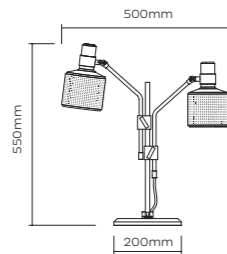

RDL0032 – Riddle Double Table Lamp
Materials = Brass
Brushed brass lacquered, Black textured powdercoat. Custom finishes available.
6W / 500lm / 2700k / CRI>80
2 x 3W LED G9-240V or E12-120V (supplied)
Mains dimmable / TRIAC (available)
Weight = 13kg net, 14.5kg gross
Standard lead time = 4 - 6 weeks
Cord = 200cm fabric cord provided
Toggle switch on base

RIDDLE SINGLE FLOOR LAMP
BRUSHED BRASS

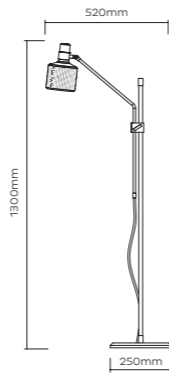

RDL0040 – Riddle Single Floor Lamp
Materials = Brass
Brushed brass lacquered, Black textured powdercoat. Custom finishes available.
3W / 250lm / 2700k / CRI>80
1 x 3W LED G9-240V or E12-120V (supplied)
Mains dimmable / TRIAC (available)
Weight = 16.5kg net, 18kg gross
Standard lead time = 4 - 6 weeks
Cord = 200cm fabric cord provided
Inline foot switch on cord

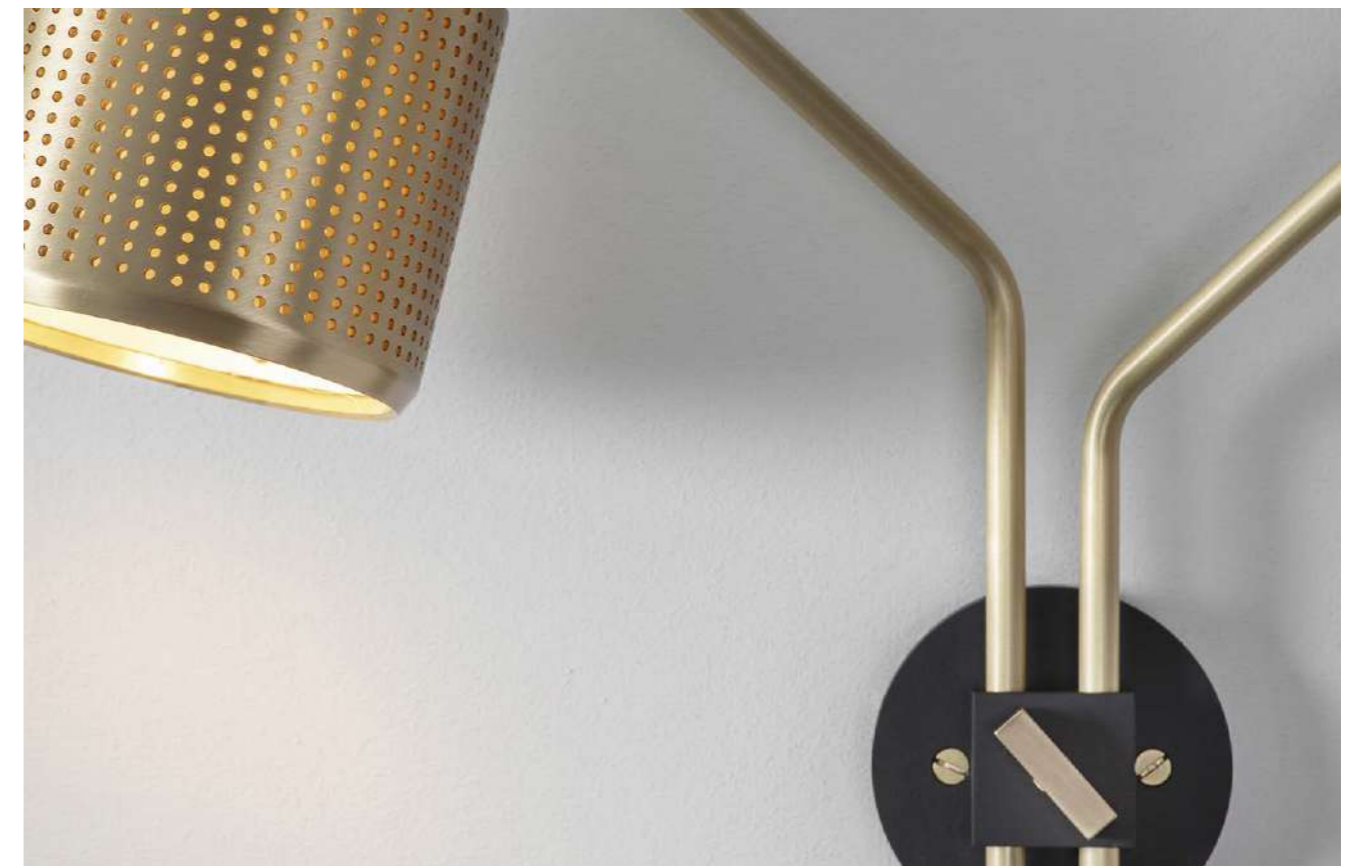

RIFT



RIFT PENDANT LIGHT
BRUSHED BRASS



RIFT WALL LIGHT
BRUSHED BRASS



RFT0010 – Rift Pendant Light
 Materials = Brass, Glass
 Brushed brass lacquered as standard
 3W / 250lm / 2700k / CRI>80
 1 x 3W LED G9-240V or E12-120V (supplied)
 Mains dimmable / TRIAC
 Weight = 3.5kg net, 4.2kg gross
 Standard lead time = 4 - 6 weeks
 Ceiling Canopy = Brushed brass round ceiling canopy H30 x R116mm
 Adjustable 200cm fabric cord provided

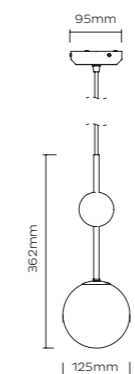

RFT0020 – Rift Wall Light
 Materials = Brass, Glass
 Brushed brass lacquered as standard
 3W / 250lm / 2700k / CRI>80 / IP44
 1 x 3W LED G9-240V or E12-120V (supplied)
 Mains dimmable / TRIAC
 Weight = 3.5kg net, 4.2kg gross
 Standard lead time = 4 - 6 weeks
 Wall Plate = Brass H350 x W150mm

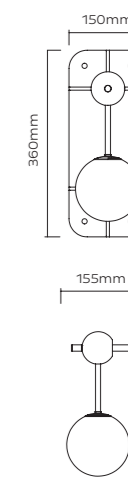



ROTE

ROTE PENDANT LIGHT SMALL
BRUSHED BRASS AND BLACK POWDERCOAT

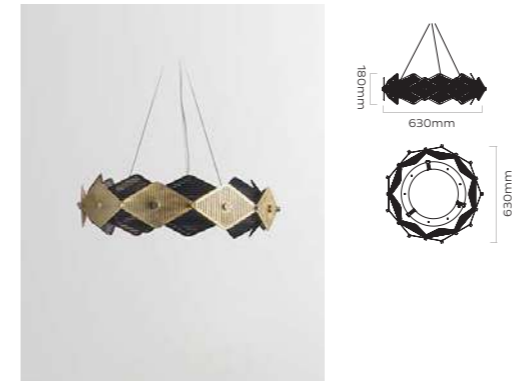

RTE0010 – Rote Pendant Light Small
Materials = Brass, Steel, Polycarbonate
Brushed brass lacquered and black powdercoat as standard
60W / 5700lm / 2700k / CRI>80
Driver = Remote 120V/240V - 60W / 24V / CV
Mains / triarc dimming
DALI/ Bluetooth dimming available
Weight = 10kg net.
Standard lead time = 4 - 6 weeks
Ceiling Canopy = Brushed brass
round ceiling canopy H30 x R120mm
3 x Adjustable suspension cables

ROTE PENDANT LIGHT MEDIUM
BRUSHED BRASS AND BLACK POWDERCOAT



RTE0011 – Rote Pendant Light Medium
Materials = Brass, Steel, Polycarbonate
Brushed brass lacquered and black powdercoat as standard
100W / 9100lm / 2700k / CRI>80
Driver = Remote 120V/240V - 100W / 24V / CV
Mains / triarc dimming
DALI/ Bluetooth dimming available
Weight = 15kg net.
Standard lead time = 4 - 6 weeks
Ceiling Canopy = Brushed brass
round ceiling canopy H30 x R120mm
3 x Adjustable suspension cables

ROTE PENDANT LIGHT LARGE
BRUSHED BRASS AND BLACK POWDERCOAT



RTE0012 – Rote Pendant Light Large
Materials = Brass, Steel, Polycarbonate
Brushed brass lacquered and black powdercoat as standard
140W / 12500lm / 2700k / CRI>80
Driver = Remote 120V/240V - 140W / 24V / CV
Mains / triarc dimming
DALI/ Bluetooth dimming available
Weight = 18kg net.
Standard lead time = 4 - 6 weeks
Ceiling Canopy = Brushed brass
round ceiling canopy H30 x R120mm
3 x Adjustable suspension cables

ROTE WALL LIGHT
BRUSHED BRASS AND BLACK POWDERCOAT

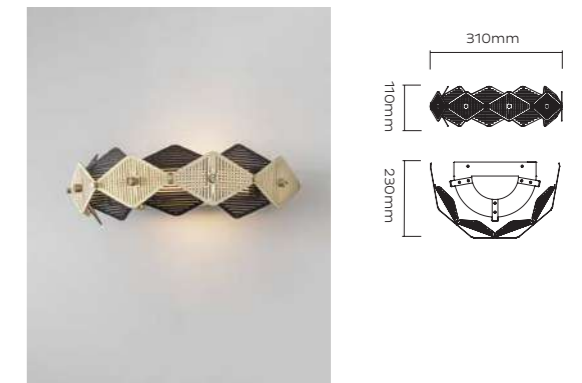

RTE0020 – Rote Wall Light
Materials = Brass, Steel, Polycarbonate
Brushed brass lacquered and black powdercoat as standard
8W / 590lm / 2700k / CRI>80
Driver = Internal 120V/240V - 20W / 24V / CV
Mains dimmable / TRIAC
Weight = 2kg net, 2.5kg gross.
Standard lead time = 4 - 6 weeks
Wall Plate = Brushed Brass Wall box -
W205 x H45 mm

ROTE TABLE LAMP

BRUSHED BRASS AND BLACK POWDERCOAT



RTE0030 - Rote Table Lamp

Materials = Brass, Steel, Polycarbonate
 Brushed brass lacquered as standard
 14W / 1100lm / 2700k / CRI>80
 Driver = 15W plug driver
 Non-dimmable as standard
 Switch dim / Bluetooth dimming available
 Weight = 6kg net, 7.5kg gross
 Standard lead time = 4 - 6 weeks
 Cord = 200cm fabric cord provided
 Inline switch on cord

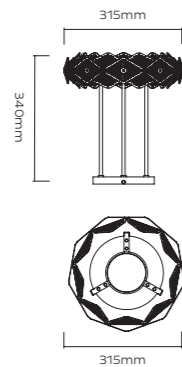

ROTE CHANDELIER

BRUSHED BRASS AND BLACK POWDERCOAT



RTE0014 - Rote Chandelier

Materials = Brass, Steel, Polycarbonate
 Brushed brass lacquered and black powdercoat as standard
 300W / 27300lm / 2700k / CRI>80
 Driver = Remote 120V/240V - 300W / 24V
 Mains / triarc dimming
 DALI/ Bluetooth dimming available
 Weight = 45kg net.
 Standard lead time = 6 - 8 weeks
 Ceiling Canopy = Brushed brass round ceiling canopy
 H70 x R450mm
 9 x Adjustable suspension cables

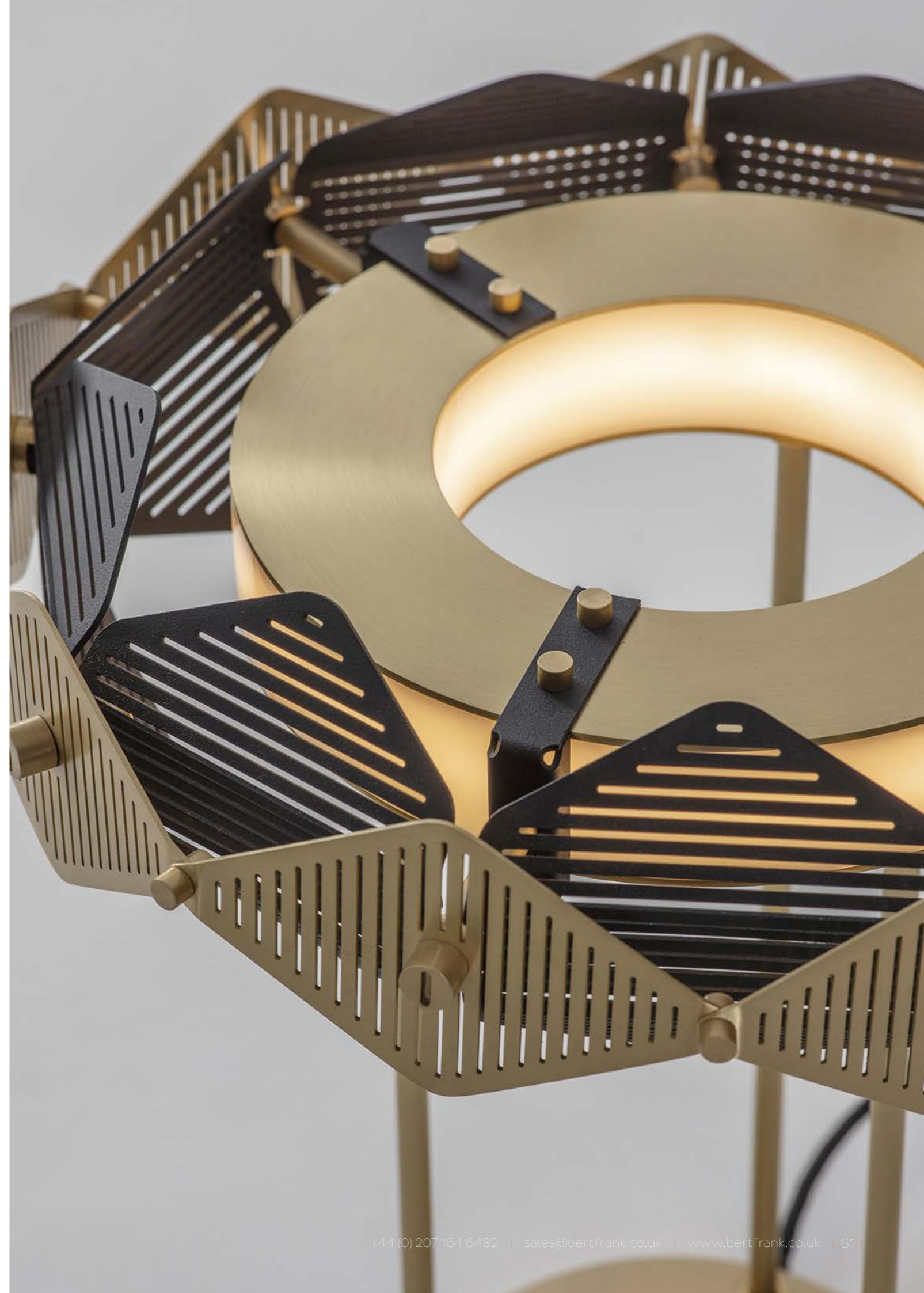
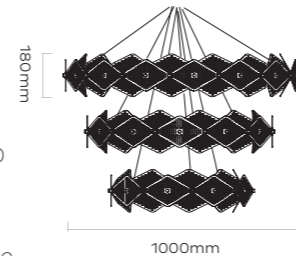

SEDDGE

SEDDGE PENDANT LIGHT BRUSHED BRASS



SDG0010 – Seddge Pendant Light
 Materials = Brass, Glass
 Brushed brass lacquered as standard
 3W / 250lm / 2700k / CRI>80
 1 x 3W LED G9-240V or E12-120V (supplied)
 Mains dimmable / TRIAC
 Weight = 3kg net, 4kg gross
 Standard lead time = 4 - 6 weeks
 Ceiling Canopy = Brushed brass
 round ceiling canopy H30 x R116mm
 Adjustable 200cm fabric cord provided

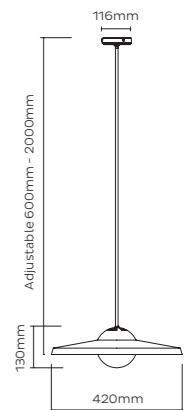



SHEAR

SHEAR PENDANT LIGHT BRUSHED BRASS



SHR0010 – Shear Pendant Light - Black
SHR0011 – Shear Pendant Light - White

Materials = Brass, Aluminium
Brushed brass lacquered as standard
Custom finishes available
3W / 250lm / 2700k / CRI>80
1 x 3W LED G9-240V or E12-120V (supplied)
Mains dimmable / TRIAC
Weight = 1.5kg net, 2.5kg gross
Standard lead time = 4 - 6 weeks
Ceiling Canopy = Brushed brass
round ceiling canopy H30 x R116mm
Adjustable 200cm fabric cord provided

SHEAR WALL LIGHT BRUSHED BRASS

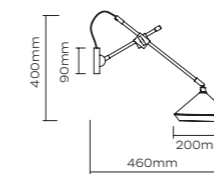

SHR0020 – Shear Wall Light - Black
SHR0021 – Shear Wall Light - White
Materials = Brass, Aluminium
Brushed brass lacquered as standard
Custom finishes available
3W / 250lm / 2700k / CRI>80
1 x 3W LED G9-240V or E12-120V (supplied)
Mains dimmable / TRIAC
Weight = 2kg net, 3kg gross
Standard lead time = 4 - 6 weeks
Wall Plate = Powdercoated 80mm wall
plate as standard

SHEAR PENDANT LIGHT XL BRUSHED BRASS

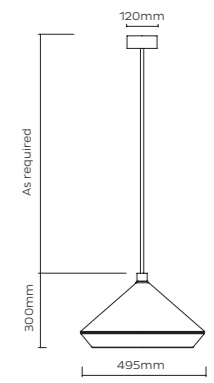

SHR0012 – Shear Pendant Light XL - Black
SHR0013 – Shear Pendant Light XL - White

Materials = Brass, Aluminium
Brushed brass lacquered as standard
Custom finishes available
1x LED E27/26 lamp (not supplied)
LED lamp only MAX 20W
Mains dimmable / TRIAC
Weight = 8.8kg net, 10kg gross
Standard lead time = 4 - 6 weeks
Ceiling Canopy = Brushed brass
round ceiling canopy H30 x R120mm
Custom brass drop rod at specified length

SHEAR TABLE LAMP BRUSHED BRASS

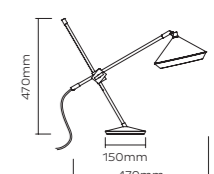

SHR0030 – Shear Table Lamp - Black
SHR0031 – Shear Table Lamp - White
Materials = Brass, Aluminium
Brushed brass lacquered as standard
Custom finishes available
3W / 250lm / 2700k / CRI>80
1 x 3W LED G9-240V or E12-120V (supplied)
Mains dimmable / TRIAC available
Weight = 4.75kg net, 6kg gross
Standard lead time = 4 - 6 weeks
Cord = 200cm fabric cord provided
Inline switch on cord

SHEAR FLOOR LAMP
BRUSHED BRASS



SHR0040 - Shear Floor Lamp - Black
SHR0041 - Shear Floor Lamp - White
Materials = Brass, Aluminium
Brushed brass lacquered as standard
Custom finishes available
6W / 500lm / 2700k / CRI>80
2 x 3W LED G9-240V or E12-120V
(supplied)
Mains dimmable / TRIAC available
Weight = 18kg net, 20kg gross
Standard lead time = 4 - 6 weeks
Cord = 200cm fabric cord provided
Inline foot switch on cord

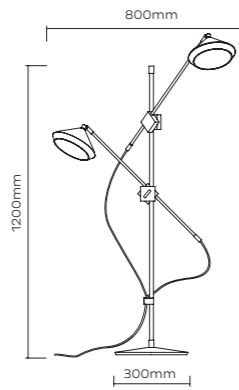

SPATE



SPATE PENDANT LIGHT BRUSHED BRASS

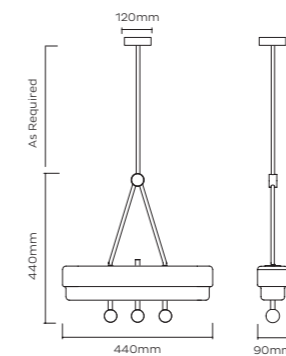

SPT0010 – Spate Pendant Light – Green
SPT0011 – Spate Pendant Light – White

Materials = Brass, Glass, Marble
Guatemalan green or Carrara white marble
Brushed brass lacquered as standard

15.5W / 1440lm / 2700k / CRI>80
15.5W Integrated 24V LED

Mains dimmable / TRIAC, External LED driver provided

Weight = 4.6kg net, 5.8kg gross
Standard lead time = 4 - 6 weeks

Ceiling Canopy = Brushed brass
round ceiling canopy H30 x R120mm
Custom brass drop rod at specified length

SPATE TABLE LIGHT BRUSHED BRASS

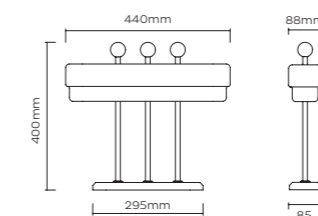

SPT0030 – Spate Table Lamp – Green
SPT0031 – Spate Table Lamp – White

Materials = Brass, Glass, Marble
Guatemalan green or Carrara white marble
Brushed brass lacquered as standard

15.5W / 1440lm / 2700k / CRI>80
15.5W Integrated 24V LED

Driver = 15W plug driver

Non-dimmable as standard

Switch dim / Bluetooth dimming available

Weight = 4.2kg net, 5.5kg gross
Standard lead time = 4 - 6 weeks

Cord = 200cm fabric cord provided
Inline switch on cord

SPATE WALL LIGHT BRUSHED BRASS

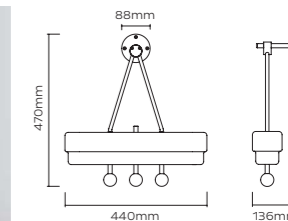

SPT0020 – Spate Wall Light – Green
SPT0021 – Spate Wall Light – White

Materials = Brass, Glass, Marble
Guatemalan green or Carrara white marble
Brushed brass lacquered as standard

15.5W / 1440lm / 2700k / CRI>80
15.5W Integrated 24V LED

Mains dimmable / TRIAC, External LED driver provided

Weight = 4kg net, 5.2kg gross
Standard lead time = 4 - 6 weeks

Wall Plate = Brushed brass 80mm wall
plate as standard

STASIS



STASIS WALL LIGHT BRUSHED BRASS

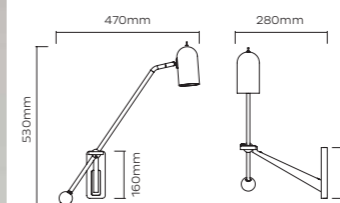

STS0020 – Stasis Wall Light – Bronze
 STS0022 – Stasis Wall Light – Polished Copper
 Materials = Brass, Copper
 Brushed brass lacquered as standard
 Custom finishes available
 3W / 250lm / 2700k / CRI>80
 1 x 3W LED G9-240V or E12-120V (supplied)
 Mains dimmable / TRIAC
 Weight = 2kg net, 3kg gross
 Standard lead time = 4 - 6 weeks
 Wall Plate = Brushed brass 80mm wall plate as standard
 Toggle switch on shade

STASIS TABLE LAMP BRUSHED BRASS

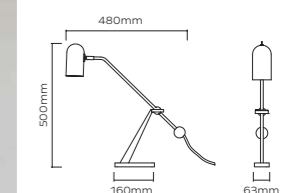

STS0030 – Stasis Table Lamp – Bronze
 STS0032 – Stasis Table Lamp – Polished Copper
 Materials = Brass, Copper
 Brushed brass lacquered as standard
 Custom finishes available
 3W / 250lm / 2700k / CRI>80
 1 x 3W LED G9-240V or E12-120V (supplied)
 Mains dimmable / TRIAC available
 Weight = 8kg net, 9.2kg gross
 Standard lead time = 4 - 6 weeks
 Cord = 200cm fabric cord provided
 Toggle switch on shade

STASIS FLOOR LAMP BRUSHED BRASS

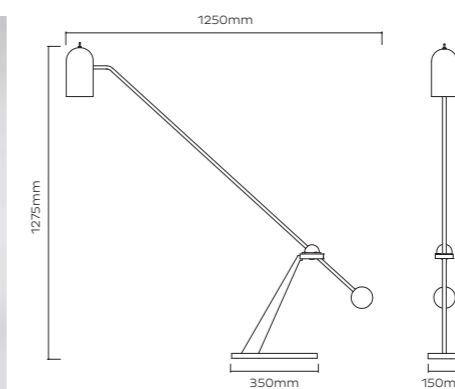

STS0040 – Stasis Floor Lamp – Bronze
 STS0042 – Stasis Floor Lamp – Polished Copper
 Materials = Brass, Copper
 Brushed brass lacquered as standard
 Custom finishes available
 1x LED E27/26 lamp (not supplied)
 LED lamp only MAX 20W
 Mains dimmable / TRIAC
 Weight = 20kg net, 22kg gross
 Standard lead time = 4 - 6 weeks
 Cord = 200cm fabric cord provided
 Toggle switch on shade

TANTO

TANTO WALL LIGHT SMALL BRUSHED BRASS

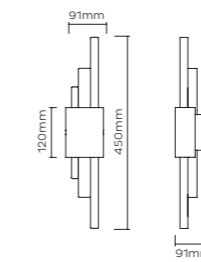

TNT0020 – Tanto Small Wall Light - Green
TNT0021 – Tanto Small Wall Light - White
TNT0024 – Tanto Small Wall Light - Black

Materials = Brass, Marble
Brushed brass lacquered as standard
Green Guatemalan, white Carrara or black Marquina marble

4.5W / 250lm / 2700k / CRI>80
1 x 4.5W LED S14D lamp provided
Mains dimmable / TRIAC

Weight = 4kg net, 5kg gross
Standard lead time = 4 - 6 weeks
Wall Plate = Brushed brass wall box - 86 x 38mm

TANTO WALL LIGHT LARGE BRUSHED BRASS

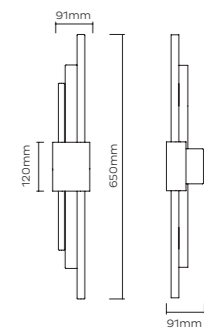

TNT0022 – Tanto Large Wall Light - Green
TNT0023 – Tanto Large Wall Light - White
TNT0025 – Tanto Large Wall Light - Black

Materials = Brass, Marble
Brushed brass lacquered as standard
Green Guatemalan, white Carrara or black Marquina marble

7W / 470lm / 2700k / CRI>80
1 x 7W LED S14D lamp provided
Mains dimmable / TRIAC

Weight = 5kg net, 5.5kg gross
Standard lead time = 4 - 6 weeks
Wall Plate = Brushed brass wall box - 86 x 38mm

TANTO WALL LIGHT DOUBLE BRUSHED BRASS

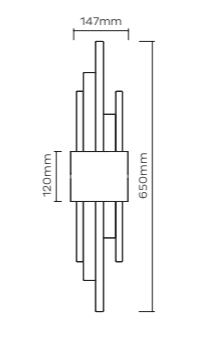

TNT0026 – Tanto Double Wall Light - Green
TNT0027 – Tanto Double Wall Light - White
TNT0028 – Tanto Double Wall Light - Black

Materials = Brass, Marble
Brushed brass lacquered as standard
Green Guatemalan, white Carrara or black Marquina marble

11.5W / 720lm / 2700k / CRI>80
1 x 4.5W, 1 x 7W LED S14D lamps provided
Mains dimmable / TRIAC

Weight = 5.5kg net, 6kg gross
Standard lead time = 4 - 6 weeks
Wall Plate = Brushed brass wall box - 86 x 86mm

TRAVE



TRAVE PENDANT LIGHT BRUSHED BRASS

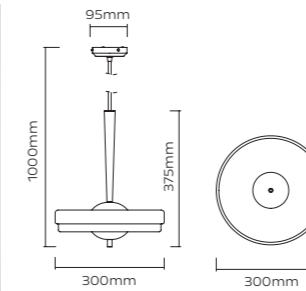

TRV0010 – Trave Pendant Light - Green
 TRV0011 – Trave Pendant Light - White
 Materials = Brass, Glass, Stone
 Brushed brass lacquered as standard
 Guatemalan green or Carrara white marble
 6W / 500lm / 2700k / CRI>80
 2 x 3W LED G9-240V or E12-120V (supplied)
 Mains dimmable / TRIAC
 Weight = 6kg net, 7kg gross
 Standard lead time = 4 - 6 weeks
 Ceiling Canopy = Brushed brass
 round ceiling canopy H30 x R116mm
 Adjustable 200cm fabric cord provided

TRAVE WALL LIGHT BRUSHED BRASS

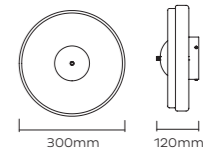

TRV0020 – Trave Wall Light - Green
 TRV0021 – Trave Wall Light - White
 Materials = Brass, Glass, Stone
 Brushed brass lacquered as standard
 Guatemalan green or Carrara white marble
 6W / 500lm / 2700k / CRI>80
 2 x 3W LED G9-240V or E12-120V (supplied)
 Mains dimmable / TRIAC
 Weight = 4kg net, 5kg gross
 Standard lead time = 4 - 6 weeks
 Wall Plate = Brushed brass R120mm wall
 plate as standard

TRAVE TABLE LAMP BRUSHED BRASS

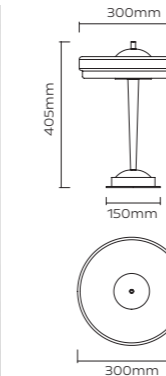

TRV0030 – Trave Table Lamp - Green
 TRV0031 – Trave Table Lamp - White
 Materials = Brass, Glass, Stone
 Brushed brass lacquered as standard
 Guatemalan green or Carrara white marble
 6W / 500lm / 2700k / CRI>80
 2 x 3W LED G9-240V or E12-120V (supplied)
 Mains dimmable / TRIAC (available)
 Weight = 7kg net, 8kg gross
 Standard lead time = 4 - 6 weeks
 Cord = 200cm fabric cord provided
 Inline switch on cord

TRIARC



TRIARC PENDANT LIGHT
BRUSHED BRASS



TRC0010 – Triarc Pendant Light – Black
TRC0011 – Triarc Pendant Light – Opal
Materials = Brass, Acrylic
Brushed brass lacquered as standard
Black or Opal polycarbonate diffusers
Custom finishes available
27W / 2250lm / 2700k / CRI>80
9 x 3W LED G9-240V or E12-120V (supplied)
Mains dimmable / TRIAC
Weight = 14kg net, 15kg gross
Standard lead time = 4 - 6 weeks
Ceiling Canopy = Brushed brass
round ceiling canopy H30 x R120mm
Custom brass drop rod at specified length

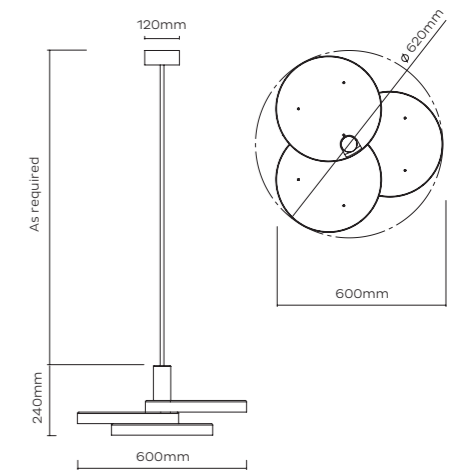

VIMA PENDANT LIGHT
BRUSHED BRASS



VMA0010 - Vima Pendant Light
Materials = Brass, Alabaster, Glass
Brushed brass as standard
6W / 500lm / 2700k / CRI>80
2 x 3W LED G9-240V or E12-120V (supplied)
Mains dimmable / TRIAC
Weight = 5.5kg net, 6.5kg gross
Standard lead time = 6 - 10 weeks
Ceiling Canopy = Brushed brass
round ceiling canopy H30 x R120mm

VIMA PENDANT LIGHT XL
BRUSHED BRASS

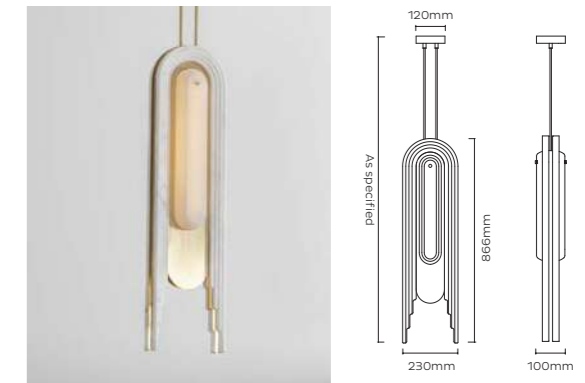

VMA0011 - Vima Pendant Light XL
Materials = Brass, Alabaster, Glass
Brushed brass as standard
13W / 1100lm / 2700k / CRI>80
Driver = 20W external driver
Mains dimmable / TRIAC
DALI / Bluetooth dimming available
Weight = 16kg net, 17kg gross
Standard lead time = 6 - 10 weeks
Ceiling Canopy = Brushed brass
round ceiling canopy H30 x R120mm
Custom brass drop rod at specified length

VIMA WALL LIGHT
BRUSHED BRASS



VMA0020 - Vima Wall Light
Materials = Brass, Alabaster, Glass
Brushed brass as standard
3W / 250lm / 2700k / CRI>80
1 x 3W LED G9-240V or E12-120V (supplied)
Mains dimmable / TRIAC
Weight = 2.3kg net, 3kg gross
Standard lead time = 6 - 10 weeks

VIMA TABLE LAMP
BRUSHED BRASS



VMA0030 - Vima Table Lamp
Materials = Brass, Alabaster, Glass
Brushed brass as standard
3W / 250lm / 2700k / CRI>80
1 x 3W LED G9-240V or E12-120V (supplied)
Mains dimmable / TRIAC
Weight = 8kg net, 9kg gross
Standard lead time = 6 - 10 weeks
Inline switch on cord

VIMA

VIMA FLOOR LAMP
BRUSHED BRASS

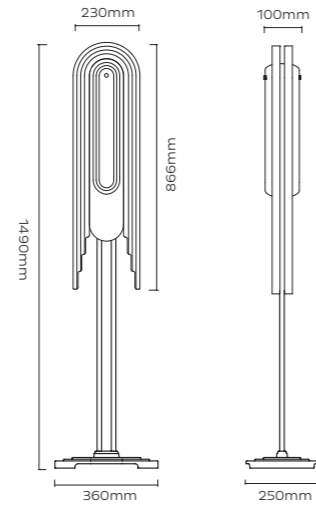

VMA0040 - Vima Floor Lamp
Materials = Brass, Alabaster, Glass
Brushed brass as standard
13W / 1100lm / 2700k / CRI>80
Driver = 20W plug driver
Non-dimmable as standard
Switch dim / Bluetooth dimming available
Weight = 30kg net, 32kg gross
Standard lead time = 6 - 10 weeks
Inline foot switch on cord





YEW

YEW WALL LIGHT
BRUSHED BRASS



YEW0020 - Yew Wall Light Left - Black
 YEW0021 - Yew Wall Light Left - White
 YEW0022 - Yew Wall Light Right - Black
 YEW0023 - Yew Wall Light Right - White
 Materials = Brass, Fabric, Aluminium
 Brushed brass lacquered as standard
 Powder coated brackets
 2x LED E27/26 lamp (not supplied)
 LED lamp only MAX 20W
 Mains dimmable / TRIAC
 Weight = 2.5kg net, 3.5kg gross
 Standard lead time = 4 - 6 weeks
 Wall Plate = Brushed brass wall box
 200 x 40mm

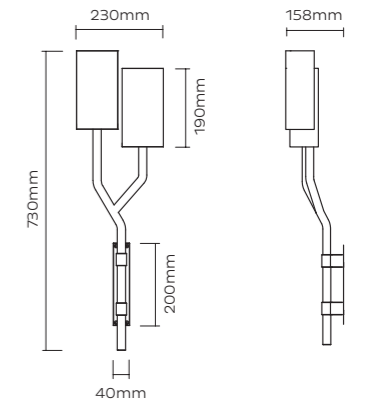



BERT
FRANK
.CO.UK



ARTI DESIGN

agence commerciale des belles marques suivantes :

www.luxonov.com & www.atelierluxus.com

Interrupteurs et prises en laiton patiné & sur mesure. Une alternative de grande qualité aux marques MELJAC et ARTE (Arnould).

www.quincalux.com

Béquilles de portes en laiton patiné haut de gamme - Tirants de tiroirs & Sur mesure.

www.bertfrank.co.uk

Luminaires en laiton massif, verre et albâtre.



www.bertfrank.co.uk